

TABLE OF CONTENTS ENGINEERING DESIGN STANDARDS

SECTION 1: GENERAL

DS1-01	Purpose	DS1.1
DS1-02	Definitions	DS1.1
DS1-03	Plan Approval	DS1.1
DS1-04	Conflicts, Errors, and Omissions	DS1.1
DS1-05	Existing Utilities	DS1.1
DS1-06	Other Agency Notifications	DS1.2

SECTION 2: CONSTRUCTION PLANS – PREPARATION, SUBMITTAL, AND PROCESSING

DS2-01	General	DS2.1
DS2-02	Preparation of Maps	DS2.1
DS2-03	Preparation of Improvement Plans	DS2.1
DS2-04	Procedure for Improvement Plans	DS2.4
DS2-05	Review and Approval Procedure for Final Maps and Parcel Maps	DS2.5
	Typical Map Statements	DS2.8
	Improvement Plan General Notes	DS2.12
	Typical Statement Sheet Layout	Fig. 2-1
	Typical Title Sheet for Improvement Plans	Fig. 2-2
	Typical Legend	Fig. 2-3A/B

SECTION 3: STREET DESIGN

DS3-01	Street Classifications	DS3.1
DS3-02	Structural Sections	DS3.1
DS3-03	Profile Standards	DS3.2
DS3-04	Street Geometrics	DS3.2
DS3-05	Partial Streets	DS3.3
DS3-06	Intersection Spacing	DS3.3
DS3-07	Cul-De-Sac	DS3.3
DS3-08	Elbow Intersection	DS3.3
DS3-09	Centerline Radii	DS3.3
DS3-10	Sight Distance at Intersections	DS3.4
DS3-11	Intersection Widening	DS3.4
DS3-12	Sidewalks	DS3.4
DS3-13	Curb and Gutter	DS3.4
DS3-14	Curb Ramps	DS3.4
DS3-15	Driveways	DS3.5
DS3-16	Easements	DS3.5
DS3-17	Valley Gutters	DS3.5
DS3-18A	New Alley Way	DS3.5

DS3-18B	Existing Alley Way	DS3.5
DS3-19	Maintenance Roads	DS3.5
DS3-20	Street Names	DS3.5
DS3-21	Street Name Sign Locations	DS3.6
DS3-22	Typical Traffic Signs	DS3.7
DS3-23	Signing and Striping	DS3.7
DS3-24	Permanent Barricades	DS3.7
	Cul-De-Sac Expanded Corner	Fig. 3-1
	Widening Details at Major Street Intersection	Fig. 3-2
	Sight Distance Typical Intersection and Driveways and Expanded Corner	Fig. 3-3A–C
	Typical Street Cross Sections	Fig. 3-4A–I
SECTION 4:	DRAINAGE DESIGN	
DS4-01	General	DS4.1
DS4-02	Design Runoff	DS4.2
DS4-03	Hydraulic Grade Line	DS4.2
DS4-04	Inlets, Gutters, and Streets	DS4.2
DS4-05	Storm Drains	DS4.3
DS4-06	Manholes	DS4.4
DS4-07	Open Channels	DS4.5
DS4-08	Detention Pond Criteria	DS4.5
DS4-09	Retention Pond Criteria	DS4.6
DS4-10	Pump Station Criteria	DS4.8
DS4-11	Additional Design Criteria	DS4.8
	Design Storm Rainfall Data	Fig. 4-1
	Retention Basin Water Balance	Fig. 4-2
	10-Year Peak Flow (0–80 Acres)	Fig. 4-3
	10-Year Peak Flow (80–640 Acres)	Fig. 4-4
	100-Year Peak Flow (0–80 Acres)	Fig. 4-5
	100-Year Peak Flow (80–640 Acres)	Fig. 4-6
	Land Uses and Impervious Percentages	Fig. 4-7
SECTION 5:	WATER SUPPLY SYSTEM DESIGN	
DS5-01	General	DS5.1
DS5-02	Distribution Facilities	DS5.3
DS5-03	Service Connections	DS5.7
DS5-04	Water Supply Facilities	DS5.9
DS5-05	Special Considerations	DS5.14
DS5-06	Design Submittal Requirements	DS5.15
	Typical Signature Block	DF-1
	Standard Fire Hydrant Location on Cul-De-Sac Streets	DF-2
	Typical Location of Service Connection	DF-3
	Typical Twin 1,000,000-Gallon Tank Site	DF-4

Typical 1,000,000-Gallon Tank Site	DF-5
Typical Direct Feed Well Facility	DF-6

SECTION 6: SANITARY SEWER DESIGN

DS6-01	General	DS6.1
DS6-02	Plan Requirements	DS6.1
DS6-03	Design	DS6.1
DS6-04	Vertical Alignment	DS6.2
DS6-05	Horizontal Alignment	DS6.3
DS6-06	Sewer Main Clearances	DS6.3
DS6-07	Appurtenances	DS6.3
DS6-08	Service Lateral	DS6.4
DS6-09	Trench Loading	DS6.4
DS6-10	Bedding and Initial Backfill	DS6.4
DS6-11	Lift Stations	DS6.4
DS6-12	Unusual Design	DS6.4

SECTION 7: STREET LIGHT DESIGN

DS7-01	Design Standards	DS7.1
DS7-02	Design Criteria	DS7.1
DS7-03	Locations	DS7.2
DS7-04	Information from P.G. & E.	DS7.2
DS7-05	Conduit	DS7.2
DS7-06	Pull Boxes	DS7.2
DS7-07	Circuit	DS7.2
DS7-08	Poles and Arms	DS7.2
DS7-09	Wire	DS7.2
DS7-10	Service	DS7.3
DS7-11	Lighting	DS7.3
	Street Light Locations, Local, Collector, Arterial Streets	Fig. 7-1A–C

SECTION 8: TRAFFIC SIGNAL DESIGN

DS8-01	General	DS8.1
DS8-02	Signal Standards	DS8.1
DS8-03	Vehicle and Pedestrian Signals	DS8.1
DS8-04	Vehicle Signal Alignment	DS8.1
DS8-05	Number and Size of Signal Indications	DS8.2
DS8-06	Vehicle Detection for a Modular (Multi or Single Camera) Video Detection System with Optional High Speed Approach Radar/ Video Fusion Technology	DS8.2
DS8-07	Conduit	DS8.2
DS8-08	Conductors	DS8.3
DS8-09	Pull Boxes	DS8.3
DS8-10	Controller Cabinet Locations	DS8.3
DS8-11	Protected vs. Permissive Left Turn Phasing	DS8.3
DS8-12	Traffic Signal Interconnect	DS8.4

DS8-13	Traffic Control Signs	DS8.4
DS8-14	Emergency Vehicle Preemptive (EVP)	DS8.4
DS8-15	Signal Phasing	DS8.4
DS8-16	Advance Flashing Beacons	DS8.4
DS8-17	Miscellaneous Appurtenances	DS8.5
DS8-18	Preparation of Plans	DS8.5
SECTION 9: SIGNING AND STRIPING DESIGN		
DS9-01	Signing and Striping	DS9.1
SECTION 10: MASONRY WALL DESIGN		
DS10-01	Location Requirements	DS10.1
DS10-02	Type	DS10.1
DS10-03	Design	DS10.1
DS10-04	Details	DS10.1
SECTION 11: SURVEY MONUMENTS		
DS11-01	Subdivision Boundary	DS11.1
DS11-02	Interior Property Lines	DS11.1
DS11-03	Street Monuments	DS11.1
DS11-04	Monument Protection	DS11.1
DS11-05	Vertical Control Benchmark	DS11.1
SECTION 12: SUBDIVISION & DEVELOPMENT GRADING PLANS		
DS12-01	Grading Plan	DS12.1
DS12-02	Grading at Trees	DS12.1
DS12-03	Confirming Pad Elevations	DS12.2
DS12-04	Grading Permit	DS12.2
DS12-05	Erosion and Sedimentation Control Plans	DS12.2
SECTION 13: IRRIGATION AND LANDSCAPING DESIGN		
DS13-01	General	DS13.1
DS13-02	Title Sheet	DS13.1
DS13-03	Construction Planting & Grading Plans	DS13.1
DS13-04	Construction Notes	DS13.1
DS13-05	Irrigation Design	DS13.7
DS13-06	Specialty Site Features	DS13.8
DS13-07	Median Island Landscaping	DS13.8
SECTION 14: DEVELOPMENT SITE ACCESS		
DS14-01	General	DS14.1
DS14-02	Driveway Locations and Spacing	DS14.1
DS14-03	Driveway Minimum Required Throat Depths	DS14.4
DS14-04	Signalized Driveways	DS14.4
DS14-05	Mid-Block Median Openings	DS14.5

Permitted Driveways/Streets on Arterials	Fig. 14-1
Right-Turn Curb Flare	Fig. 14-2

SECTION 15: TRANSPORTATION IMPACT ANALYSIS

DS15-01	General	DS15.1
DS15-02	Definitions	DS15.1
DS15-03	Local Transportation Analysis (LTA) Thresholds	DS15.1
DS15-04	Trip Generation Letter Requirements	DS15.2
DS15-05	Focused Local Transportation Analysis Requirements	DS15.4
DS15-06	Scope for Full Local Transportation Analysis Report	DS15.4
DS15-07	CEQA VMT Analysis	DS15.9
DS15-08	Report Submittals	DS15.14
	Local Transportation Analysis Requirements	Fig. 15-1
	VMT Screening Process	Fig. 15-2
	VMT Per Capita by TAZ	Fig. 15-3
	VMT per Employee by TAZ	Fig. 15-4

This Page Intentionally
Left Blank

ENGINEERING DESIGN STANDARDS

SECTION 1 – GENERAL

DSI-01. PURPOSE: These design standards are a guide for development of public facilities with the City of Dixon. They are intended to assure equitable appreciation of ordinances, rules, and regulations.

These are minimum standards and may be modified by the City at any time these criteria or methods do not appear to be applicable or as new techniques are developed. Minor modifications may be allowed for sound engineering reasons, but the burden of proof will be on the Design Engineer. The decision of the City Engineer shall be final in all cases.

Any situations not included in these standards shall be designed in accordance with acceptable engineering practice and as approved by the City Engineer. Specifically, the following design manuals shall be used, in order of precedence:

1. Caltrans Highway Design Manual, 2018 edition
2. Manual on Uniform Traffic Control Devices, MUTCD, with California Supplement, latest edition
3. State of California Standard Plans for construction of local streets and roads, latest edition
4. State of California Standards Specifications for construction of local street and roads, latest edition
5. A policy on geometric design of highways and streets, AASHTO, latest edition

These design standards are necessary in order to provide for coordinated development of required public facilities to be used by and for the protection of the public.

DSI-02. DEFINITIONS: In these standards, the intent and meaning of the terms that are used shall be as defined in Section G-1 of the City General Provisions.

DSI-03. PLAN APPROVAL: No plans will be approved nor construction authorized until such time as the City Engineer signifies approval by signing the set of improvement plans or dimension sketch. The City Engineer will sign the tracings in the space provided, after the Design Engineer has signed the plans, all the appropriate City fees have been paid, and all required bonds posted. The City Engineer's approval is valid for a period of 12 months. Should work not commence within the 12-month period, the plans shall be resubmitted for reapproval.

DSI-04. CONFLICTS, ERRORS, AND OMISSIONS: Excepted from approval are any features of the plans that are contrary to, in conflict with, or do not conform to any Federal Law, California State Law, City Code, conditions of approval, or generally accepted good engineering practice, in keeping with the standards of the profession, even though such errors, omissions or conflicts may have been overlooked in the City Engineer review of the plans.

DSI-05. EXISTING UTILITIES: All existing utilities are to be shown on the plans. In addition, the Design Engineer shall submit prints of the preliminary and approved plans to the utility companies involved. This is necessary for the utility companies to properly plan their relocation projects and needed additional facilities. Copies of the transmittal letters to the utility companies shall be provided to the City Engineer. The transmittal letters shall indicate all conflicts which require relocation.

If there are required alterations or revisions to the improvement plans as submitted that may affect the utility design, the Design Engineer shall resubmit the preliminary plans to each of the utility companies.

The Design Engineer is responsible for obtaining written approval of the plans from the utilities and for delivering the approval letters to the City of Dixon.

In addition, the following note shall appear on the street light plan if no approval letters are received from the utilities before the City Engineer signs the improvement plans:

“No approval of street subgrade until all the utility letters are received by the City of Dixon.”

DSI-06. OTHER AGENCY NOTIFICATIONS: The Design Engineer is responsible for obtaining the approval and necessary permits of governmental or municipal agencies when their facilities are involved.

ENGINEERING DESIGN STANDARDS

SECTION 2 – CONSTRUCTION PLANS PREPARATION, SUBMITTAL, AND PROCESSING

DS2-01. GENERAL: Complete plans and specifications for all proposed improvements including proposed streets, bikeways, grading, erosion control, drainage facilities, sewerage, street lighting, water distribution systems, landscaping and any necessary dedications and easements shall be submitted to the City of Dixon City Engineer and must receive the required approval by the City Engineer prior to the beginning of construction of any portion of such improvements within the public right-of-way. Such plans shall be prepared by a California Registered Civil Engineer in accordance with the provisions of "Civil Engineer's Act" Chapter 7, Division 3 of the Business and Professions Code, relating to the practice of Civil Engineering.

DS2-02. PREPARATION OF MAPS: Final Maps and Parcel Maps shall be prepared in conformance with the current Subdivision Map Act, the City of Dixon Subdivision Ordinance, and as follows:

- A. DIMENSIONS:** Maps shall be clearly and legibly drawn on 26 inch by 18 inch sheets with a 1-inch margin on all sides.
- B. SCALE:** The scale of the map shall be 1 inch equals 50 feet or 100 feet and enough sheets shall be used to accomplish this end. A graphical scale not less than 3 inches in length shall be shown in addition to numerical scale.
- C. FORM:** The statement sheet shall be drafted so that the statements (See Figures 2-1A thru 2-1C as applicable) will appear in the form and location as shown in Figure 2-2. The statements shall be appropriately completed and signed in the following order:
 - 1. Owner
 - 2. Notary Public
 - 3. Trustee (if applicable)
 - 4. Trustee's Notary
 - 5. Engineer (or surveyor)
 - a. Community Development Director
 - b. City Engineer
 - c. Solano Irrigation District (if applicable)
 - d. City Clerk
 - 6. Tax Collector
 - 7. County Recorder

DS2-03. PREPARATION OF IMPROVEMENT PLANS:

- A. DIMENSIONS:** Construction plans shall be clearly and legibly drawn on 36 inch by 24 inch sheets with a 1-1/2 inch clear margin on the left edge and 1/2 inch margins on all other edges.

B. **SCALE:** Horizontal scale shall be 1" = 40'; vertical scale shall be 1" = 4' or as approved. Numeric and graphic scale shall appear on each sheet.

C. **FORM:**

1. Title Sheet (See Figure 2-3)
 - a. Name and number of subdivision or, for CIP projects, the project name and location.
 - b. Plan view showing the entire street right-of-way layout (Scale: 1" = 100'), proposed water and sewer mains, storm drainage system, lot numbers and other miscellaneous improvements to be installed.
 - c. Index of Sheets.
 - d. Complete Legend. (See Figures 2-4A and 2-4B)
 - e. Vicinity Map with North Arrow.
 - f. Title Block - shall conform to engineering standards located across the bottom edge of the sheet with the sheet number located in the lower right hand corner. This is typical of each and every sheet.
 - g. Temporary and permanent bench marks including their descriptions.
2. General Notes - A list of City-required general notes shall be shown for all development plans (See Pages DS2.15 thru 2.24).
3. Detail Sheet - Project specific construction details shall be shown including typical street sections.
4. Street Plan and Profile Sheets
 - a. Plan view of each street to be improved shall be shown on separate sheets indicating existing improvements, proposed improvements and future improvements, if known. Improvement plans shall include the following items where applicable:

Streets & Sidewalks	Sewer Mains	Water mains & valves	Streetlights
Curb & Gutter	Storm drain lines	Water service laterals	Pull boxes & conduit
Driveways	Service laterals	Fire hydrants	Existing signs, trees, etc.
Street signs	Sampling stations	Survey stationing	Proposed lot numbers
Monuments	Manholes	Joint trenches	SID Irrigation lines
Fences & barricades	Drainage inlets	PG&E service points	

Survey stationing shall read from left to right with the north arrow pointing either to the top or right edge of the sheet. Stationing shall be a continuation of existing improvements where possible.

- b. Profile view of each street shall be shown immediately below its plan view. The profile shall include existing grade lines, sewer mains, storm drains, water mains, public utility mains, all utility crossings, and top of curb. Elevations shall be shown at top of curb at grade break points, manhole and catch basin inverts, and water main crossings with other utilities.
- c. Draftsmanship: All line work must be clean, sharp and heavy. Letters and numerals must be 1/8" minimum height, well formed and sharp. Numerals showing profile elevations shall not be bisected by station grid lines. Mechanically generated lettering may be 1/10" minimum height.
- d. Right-of-way: Right-of-way lines, the boundaries of lots fronting on the street, drainage easements, utility easements, landscape easements, section lines and corners, land grant lines and temporary construction easements,

both existing and proposed, shall be shown on the plans. All right-of-way and easement lines shall be properly dimensioned.

- e. Topography: All pertinent topographic features shall be shown, such as street lines, medians, driveways (on both sides of the street when within 40 feet of the median ending), curbs, sidewalks, shoulders, location and size of storm and sanitary sewer lines, high water and frequent inundation levels, water lines, gas lines, telephone conduits, other underground utilities, existing structures, houses, trees (6" diameter and larger) and other foliage, traffic signals, streetlights and pullboxes, underground electrical conduits, drainage ditches, utility poles, fire hydrants, retaining walls, masonry structures, and all other features of the area which may affect the design requirements for the area. When a potential utility conflict exists, "as built" elevations of the utilities shall be verified by the Design Engineer.
 - f. Contours and Elevations: Existing contours or supporting elevations shall be shown on all plans.
 - g. Profiles: The plans shall show the existing profile of all roadway centerline, edges of pavement, curb and gutter flow lines, drainage ditches, storm and sanitary sewers. All profiles of proposed improvements shall state centerline elevations at 50 foot intervals and rate of grades, vertical curves and other vertical alignment data, and shall show all existing utilities. Any vertical curve shall set elevations at 25 foot intervals.
The plans shall show the existing ground profile for a minimum distance of 200 feet beyond temporary street endings to facilitate setting proper vertical alignment within the proposed improvement limits. The 200-foot minimum shall be increased when requested by the City Engineer.
 - h. Stationing and Orientation: All plan and profiles shall be coordinated with City stationing. The Design Engineer shall contact the City for such stationing.
The stationing on plan and profile shall read from left to right. Stationing shall increase from south to north or from west to east. Plans shall be so arranged that the north arrow points toward the top right edge of the sheet unless approved otherwise by the City Engineer.
 - i. Bench Marks: The bench marks and datum shall be clearly delineated on the plans both as to location, description and elevations. If the proposed improvements are over 1,000' from any existing bench mark, a new bench mark shall be established and tied into the City system.
 - j. Typical Sections: A typical section for each type of facility within the improvement, setting out the structural features, shall be a part of the plans.
 - k. Cross Sections: Cross sections shall be required where an existing street is being widened and on all City projects. Cross sections shall be included for all changes in street right-of-way dimensions. The cross sections shall show all existing and proposed elevations, points of conform, and all dimensions and slopes. The sections shall be drawn at a scale that will allow a detailed review of the design.
5. Water Plan: See Section DS5 for requirements.
 6. Grading Plan: Grading plan shall include building pad elevations, individual lot drainage pattern, adjacent land drainage, driveway locations, fencing, existing contours at 1-foot intervals, or spot shots at 50-foot intervals and existing trees, wells, ditches and other landmarks important in the construction of the improvements. In addition, adjacent lot gradings shall be shown. The site development plans shall conform to F.H.A. Standards. See Section DS12, "Subdivision Grading Plan," for requirements.
 7. Erosion Control Plan: Erosion Control Plan shall follow the guidelines of the Stormwater Pollution Prevention Plan (SWPPP). The plan shall include site

- maps(s), and identification of construction/contractor activities describing measures for providing erosion and sediment control. The SWPPP shall be submitted with the first improvement plan submittal.
8. Streetlight Plan: See Section DS7, “Street Light Design,” for requirements.
 9. Signing and Striping Plan: The proposed Public Improvement Plans shall include a plan sheet which will show the existing and proposed signing and striping of streets within the project area. This plan can be incorporated into the Street Light Plan and shall be titled “Street Light and Striping Plan.” See Section DS9, “Signing and Striping of Streets,” for requirements.
 10. Detour Plan: When the City Engineer requires a detour plan, all signs, striping, flag persons, and traffic control devices shall conform to the latest California Department of Transportation standards.

DS2-04. PROCEDURE FOR IMPROVEMENT PLANS:

A. IMPROVEMENT PLAN SUBMITTAL

NOTE: Improvement Plans shall be completed and approved prior to acceptance of a Final or Parcel map for processing as per the City of Dixon Subdivision Ordinance. A Final or Parcel map shall not be deemed to be submitted for approval until the approval of the Improvement Plans by the City Engineer.

No work shall be commenced by the Contractor on any public improvement until the City Engineer has approved the Improvement Plans.

Upon submittal of Improvement Plans, the City Engineer will determine the adequacy of the support data, and will notify the Design Engineer if additional information is required prior to beginning the Improvement Plan check. If the Plans submitted are not prepared in accordance with these Engineering Design Standards and Construction Specifications or not in accordance with acceptable standards of the profession, the City Engineer may return them unmarked and unapproved.

In the event any of the required items are not submitted, or if a significant number of the items are incomplete, the City Engineer may determine that the project is not suitable for review.

The initial submittal of improvement plans to the Engineering shall consist of the following items:

1. Electronic set of plans, complete and in accordance with these Engineering
2. Design Standards and Construction Specifications, along with any required specifications.
3. Electronic set of landscaping plans, if applicable.
4. Submittals required for Storm Drain Design: (Two copies of each)
 - a. Tributary Area Map
 - b. Runoff Calculations
 - c. Grading Plan
 - d. Storage Volume Calculations for Street and Detention Basin Storage (if applicable)
 - e. Hydraulic Grade Line Elevations for 5-year, 10-year 100-year storms at each inlet.
5. Stormwater Pollution Prevention Plan (SWPPP)
6. Sewer Analysis and Map. See Section DS6-03(F) for additional information.

7. Electronic copy of the soils report which includes establishment of the soils "R" value and recommendations for street section design based on traffic index shown in Section 3, Street Design.
8. Electronic copy of approved tentative map and/or conditions of approval.
9. Electronic copy of the approved environmental document, including environmental impact report mitigation requirements if applicable.
10. Electronic copy of legal description of proposed easements and diagram showing location (if not covered by a map).
11. Cost estimate for public improvements.
12. Payment of fees
13. Plan check deposit
14. The name, address, and telephone number of the developer.
15. Preliminary utility letters.
16. Joint Trench Plan (if applicable).

Should there be required revisions to the plans as submitted, the City Engineer will return comments with necessary revisions to be made and/or one copy with the corrections marked or indicated thereon for the Design Engineer to resubmit.

- B. IMPROVEMENT PLAN RESUBMITTAL:** Plans being resubmitted shall consist of 7 complete sets of plans along with original redlined plan check set. Additional sets may be required by the City Engineer.

At the discretion of the City Engineer, plan check resubmittal may be submitted electronically along with an electronic copy of the redlined plan check set. Plans being resubmitted that contain revisions or alterations other than those required by the City Engineer on previously corrected plans shall require the Design Engineer to bring those revisions or alterations to the attention of the City Engineer.

If the Design Engineer has not made all the corrections, a list shall be submitted of uncorrected items, stating why the corrections have not been made. This process will continue until the plans are ready for approval.

NOTE: In special circumstances, and with approval by the City Engineer, a grading permit may be issued prior to improvement plan final approval and signing. Developer is proceeding at their own risk and is responsible for any changes required by the signed improvement plans.

- C. IMPROVEMENT PLAN APPROVAL:** When the plans are deemed ready for approval, the developer shall enter into an improvement agreement, pay the appropriate fees and post required bonds. At that point, a mylar or sepia set of plans will be forwarded to the City Engineer for signature. Plans will not be considered approved until signed by the City Engineer or his representative. After approval by the City Engineer, the Design Engineer will furnish the City three sets of plans prior to starting construction.

When the Improvement Plans are accepted and signed by the City, the final utility letter shall be sent to each of the utility companies.

If no approval letters have been received from the utilities before the Improvement Plans are signed by the City Engineer, the following note shall appear on the streetlight plans:

“No approval of street subgrade until all the utility letters are received by the City of Dixon.”

Signed Improvement Plans are released to the developer and construction may begin.

A pre-construction meeting may be scheduled if required by the City Engineer.

D. IMPROVEMENT PLAN REVISIONS: Should changes become necessary during construction, the Design Engineer shall first obtain the consent of the City

Engineer and shall then resubmit the title sheet and the plan sheets affected for approval. The changes on the plans shall be made in the following manner:

1. The original proposal shall not be eradicated from the plans but shall be lined out. In the event that eradicating the original proposal is necessary to maintain clarity of the plans, approval must first be obtained from the City Engineer.
2. The changes shall be clearly shown on the plans with the changes and approval noted on a revision signature block.
3. The changes shall be identified by the revision number in a triangle delineated on the plans adjacent to the change and on the revision signature block. Very minor changes which do not affect the basic design or contract may be made upon the authorization of the City Engineer. The City Engineer may order changes in the plans in order to complete the necessary facilities. Changes in the plans ordered by the City Engineer shall conform to all of the above.
4. For City projects, the Design Engineer must submit the design change in writing via a City Change Order to the City Engineer for approval.

E. IMPROVEMENT PLAN RECORD DRAWINGS: Upon completion of the improvements and prior to acceptance or sign-off by the City as applicable, the Design Engineer is to prepare and submit one set of as-built record drawing mylars (double matte, 3 mil, sepia toned), two sets of blue line as-built record drawing prints, and disk copies of plan computer files in AutoCAD, Adobe Acrobat PDF and TIFF image files at 300 DPI format to the City. Contact the City regarding AutoCAD release format required for the plan file.

DS2-05. REVIEW AND APPROVAL PROCEDURE FOR FINAL MAPS, PARCEL MAPS:

A. Prior to preparation of the Final Map or Parcel Map, Improvement Plans shall be approved by the City Engineer as per the City of Dixon Subdivision Ordinance. A Final Map or Parcel Map shall not be deemed to be submitted for approval until the approval of the Improvement Plans by the City Engineer. If the Map submitted is not prepared in accordance with these Design Standards or not in accordance with acceptable Standards of the profession, the City Engineer may return them unmarked or unapproved. In the event any of the required items are not submitted, or if a significant number of the required items are incomplete, the City Engineer may determine that the Map is not acceptable for review.

B. The Design Engineer prepares and submits Final Map or Parcel Map, to the City Engineer.

- C. The following items must be presented with the original submittal:
1. All information required by California Subdivision Map Act, City Subdivision Ordinance, and Engineering Design Standards and Construction Specifications.
 2. Final Map or Parcel Map Application including:
 - a. Electronic copy of the Final or Parcel Map.
 - b. One (1) 8-1/2"x11" reproducible copy of map.
 - c. Electronic copy of the Vesting Deed, Preliminary Title Report (current within last 30 days), copies of deeds referenced.
 - d. Electronic copy of the closure calculations with parcel acreage.
 - e. Electronic copy of Tentative Maps with conditions of approval.
 3. Payment of fees.
- D. City checks data in Step B and returns to Design Engineer for changes and/or corrections. Improvement Agreement is prepared and sent to Developer for review. Developer submits to City a copy of the developer's insurance policy for approval.
- E. Design Engineer makes all changes and/or corrections and submits corrected Final Map. Developer returns Agreement with any comments or with a letter stating the Agreement is acceptable as is.
- F. Steps "C" and "D" are repeated until Map and Agreement are acceptable to the City.
- G. Developer delivers executed agreement, and all items required by said agreement (i.e., fees, deeds, etc.) to the City Engineer. For Final Maps, this submittal shall be at least fourteen (14) days prior to desired date for City Council action on the Final Map and Improvement Agreement.
- H. Upon request by the City, Design Engineer submits signed originals and necessary copies of the Map for City Council approval and electronic copy of Map files in AutoCAD, Adobe Acrobat PDF and TIFF image files at 300 DPI format. Contact the City regarding the AutoCAD release format required for the Map files.
- I. City Engineer signs the Map, then submits the Map to the City Clerk for signature.
- J. City Clerk and City Manager sign the Improvement Agreements and City Clerk may record Map and Agreement. Developer's title company may be required to pick up the Map and Improvement Agreement and have them recorded at the County Recorder's Office.

TYPICAL MAP STATEMENTS

(Standard forms for Construction Plans-Preparation, Submittal and Processing)

OWNER'S TRUSTEE STATEMENT

[I]WE, THE UNDERSIGNED, DO HEREBY CONSENT TO THE PREPARATION AND FILING OF THIS MAP AND WE DO HEREBY CERTIFY THAT IN ORDER TO PASS CLEAR TITLE TO THE LAND DELINEATED WITHIN THE EXTERIOR BOUNDARY OF THIS _____ MAP THE CONSENT OF NO OTHER PERSONS ARE NECESSARY.

[I]WE DO HEREBY IRREVOCABLY OFFER FOR DEDICATION _____ TO THE PUBLIC AS AND FOR PUBLIC THOROUGHFARES, ALL STREETS, DRIVES, COURTS AND WAYS, AS SHOWN THEREON; AND WE ALSO HEREBY IRREVOCABLY OFFER FOR DEDICATION FOR SPECIFIC PURPOSES THE FOLLOWING RIGHTS-OF-WAY AND EASEMENTS FOR DRAINAGE, LANDSCAPING, WATER, SEWER, GAS PIPES, POWER, LIGHTS, TELEVISION CABLES AND TELEPHONE CABLES; AND ANY AND ALL OTHER UTILITY SERVICES TOGETHER WITH ANY AND ALL NECESSARY APPURTENANCES IN EACH CASE, IN, OVER AND ACROSS THOSE STRIPS OF LAND SHOWN OR DESIGNATED AS PUBLIC SERVICE EASEMENTS (P.S.E.)]

[I]WE DO HEREBY RELINQUISH ALL ABUTTERS RIGHTS TO INGRESS AND EGRESS AS DELINEATED HEREON (//////) AS NON-ACCESS EASEMENTS.]

[I][WE ALSO HEREBY GRANT EXCLUSIVE RIGHT OF VEHICULAR INGRESS AND/OR EGRESS TO THE CITY OF DIXON ACROSS LOT LINES SHOWN HEREON AND DESIGNATED "NO INGRESS, EGRESS RIGHTS LINE."]
[LOT _____ IN FEE TO THE CITY OF DIXON FOR LANDSCAPING PURPOSES.]

BY: _____
(NAME OF ENTITY) (TITLE)

NOTARY'S STATEMENT

STATE OF CALIFORNIA
COUNTY OF SOLANO

ON THIS _____ DAY OF _____, 20____, BEFORE ME, _____, A NOTARY PUBLIC IN AND FOR THE STATE OF CALIFORNIA, PERSONALLY APPEARED _____, PERSONALLY KNOWN TO ME AS TO BE THE PERSON[S] WHOSE NAME[S] IS[ARE] SUBSCRIBED TO THE WITHIN INSTRUMENT, AND ACKNOWLEDGED TO ME THAT HE[SHE][THEY] EXECUTED THE SAME IN HIS[HER][THEIR] AUTHORIZED CAPACITY, AND THAT BY HIS[HER][THEIR] SIGNATURE ON THE INSTRUMENT THE PERSON[S], OR ENTITY UPON BEHALF OF WHICH THE PERSON[S] ACTED, EXECUTED THE INSTRUMENT.

WITNESS MY HAND AND OFFICIAL SEAL THE DAY AND YEAR FIRST ABOVE WRITTEN.

NOTARY PUBLIC
DATE: _____

COUNTY TAX COLLECTORS STATEMENT

I, _____, TAX COLLECTOR OF SOLANO COUNTY, CALIFORNIA, DO HEREBY CERTIFY THAT ACCORDING TO THE RECORDS OF THIS OFFICE THERE ARE NO LIENS AGAINST THIS SUBDIVISION OR ANY PART THEREOF FOR UNPAID STATE, COUNTY, MUNICIPAL OR LOCAL TAXES OR SPECIAL ASSESSMENTS COLLECTED AS TAXES, EXCEPT TAXES OR SPECIAL ASSESSMENTS NOT YET PAYABLE.

I ALSO CERTIFY THAT A GOOD AND SUFFICIENT BOND, TO THE BENEFIT OF THE COUNTY OF SOLANO, HAS BEEN FILED WITH THIS OFFICE IN THE SUM OF \$ _____, WHICH IS THE AMOUNT ESTIMATED BY THE ASSESSOR OF THE COUNTY OF SOLANO AS BEING A LIEN BUT NOT YET PAYABLE FOR TAXES AND SPECIAL ASSESSMENTS AGAINST THE LAND CONSTITUTING THIS SUBDIVISION; AND THAT ALL CERTIFICATIONS REQUIRED UNDER THE PROVISIONS OF SECTION 66492 AND 66493 OF THE GOVERNMENT CODE HAVE BEEN FILED. THIS CERTIFICATE VOID AFTER _____ FILE NO. _____.

DATED _____

COUNTY TAX COLLECTOR
COUNTY OF SOLANO, CALIFORNIA
BY: _____
DEPUTY

COUNTY RECORDER'S STATEMENT

FILED AT THE REQUEST OF _____ AT _____: _____ M ON THE _____ OF _____
_____, 20____, IN THE OFFICE OF THE COUNTY RECORDER OF SOLANO COUNTY IN BOOK _____ OF [PARCEL]
[SUBDIVISION] MAPS AT PAGE _____, AS INSTRUMENT NUMBER _____.

COUNTY RECORDER
BY: _____, DEPUTY RECORDER

CITY CLERK'S STATEMENT

I, THE UNDERSIGNED, CLERK OF THE CITY COUNCIL OF THE CITY OF DIXON, HEREBY STATE THAT THE CITY COUNCIL DID ON THE _____ DAY OF _____, 20____, APPROVE THIS _____ MAP ENTITLED _____

_____ AND AT THAT TIME REJECTED, ON BEHALF OF THE PUBLIC, ANY REAL PROPERTY OFFERED FOR DEDICATION AS PUBLIC RIGHTS-OF-WAY OR PUBLIC SERVICE EASEMENTS IN CONFORMITY WITH THE TERMS OF THE IRREVOCABLE OFFER OF DEDICATION.

IN WITNESS WHEREOF, I HAVE HEREUNTO SET MY HAND ON THIS _____ DAY OF _____ 20____.

CITY CLERK, CITY OF DIXON

SURVEYOR'S STATEMENT (FINAL MAPS ONLY)

I HEREBY STATE THAT THIS MAP OF " _____ " WAS PREPARED BY ME OR UNDER MY DIRECTION AND IS BASED UPON A FIELD SURVEY IN CONFORMANCE WITH THE REQUIREMENTS OF THE SUBDIVISION MAP ACT AND LOCAL ORDINANCE AT THE REQUEST OF _____ IN _____ 20__ AND IS TRUE AND COMPLETE AS SHOWN. I HEREBY STATE THAT THIS MAP SUBSTANTIALLY CONFORMS TO THE CONDITIONALLY APPROVED TENTATIVE MAP; THAT THE MONUMENTS (WILL BE OF THE CHARACTER AND WILL OCCUPY THE POSITIONS INDICATED) (WILL BE SET UPON THE COMPLETION OF THE REQUIRED SUBDIVISION IMPROVEMENTS ON OR BEFORE _____ 20__.) AND THAT SAID MONUMENTS WILL BE SUFFICIENT TO ENABLE THE SURVEY TO BE RETRACED.

DATED _____ (NAME) _____ (RCE [LS] NUMBER)
EXPIRES: _____

(NOTE: SURVEYOR SHALL POST A BOND IF INTERIOR MONUMENTS ARE TO BE SET AT A LATER DATE.)

SURVEYOR'S STATEMENT (PARCEL MAPS ONLY)

THIS MAP WAS PREPARED BY ME OR UNDER MY DIRECTION [AND WAS COMPILED FROM RECORD DATA] [AND IS BASED UPON A FIELD SURVEY] IN CONFORMANCE WITH THE REQUIREMENTS OF THE SUBDIVISION MAP ACT AND LOCAL ORDINANCE AT THE REQUEST OF _____ ON _____. I HEREBY STATE THAT THIS PARCEL MAP SUBSTANTIALLY CONFORMS TO THE APPROVED OR CONDITIONALLY APPROVED TENTATIVE MAP, THAT THE MONUMENTS (WILL BE OF THE CHARACTER AND WILL OCCUPY THE POSITIONS INDICATED) (WILL BE SET UPON COMPLETION OF THE REQUIRED SUBDIVISION IMPROVEMENTS ON OR BEFORE _____ 20__), IF ANY, AND THAT ALL MONUMENTS ARE, OR WILL BE, SUFFICIENT TO ENABLE THE SURVEY TO BE RETRACED.

DATED _____ (NAME) _____ (RCE [LS] NUMBER)
EXPIRES: _____

(NOTE: SURVEYOR SHALL POST A BOND IF INTERIOR MONUMENTS ARE TO BE SET AT A LATER DATE.)

CITY ENGINEER'S STATEMENT (FINAL MAPS ONLY)

I, _____, DO HEREBY CERTIFY THAT I HAVE EXAMINED THIS FINAL MAP ENTITLED " _____ " AND HAVE FOUND IT TO BE SUBSTANTIALLY THE SAME AS IT APPEARED ON THE TENTATIVE MAP AND ANY APPROVED ALTERATION THEREOF. I AM SATISFIED THAT THE MAP IS TECHNICALLY CORRECT AND THAT ALL PROVISIONS OF THE SUBDIVISION MAP ACT AND OF THE ORDINANCES OF THE CITY OF DIXON HAVE BEEN COMPLIED WITH.

DATED _____ CITY ENGINEER, CITY OF DIXON
LICENSE : R.C.E. [L.S.]# _____
EXPIRES: _____

NOTE: REQUIRES R.C.E. PRIOR TO JANUARY 1, 1982 OR LICENSED SURVEYOR TO EXECUTED THIS STATEMENT.

CITY ENGINEER'S STATEMENT (PARCEL MAPS ONLY)

I, _____, DO HEREBY CERTIFY THAT I HAVE EXAMINED THIS PARCEL MAP AND FOUND IT TO BE SUBSTANTIALLY THE SAME AS THE TENTATIVE MAP AND ANY APPROVED ALTERATION THEREOF SUBMITTED TO THE PLANNING COMMISSION OF THE CITY OF DIXON; THAT ALL PROVISIONS OF THE SUBDIVISION MAP ACT AND ALL CITY ORDINANCES APPLICABLE AT THE TIME OF APPROVAL OF THE TENTATIVE MAP HAVE BEEN COMPLIED WITH; AND THAT SAID MAP IS TECHNICALLY CORRECT.

DATED _____
_____ CITY ENGINEER, CITY OF DIXON
LICENSE : R.C.E. [L.S.]# _____
EXPIRES: _____

NOTE: REQUIRES R.C.E. PRIOR TO JANUARY 1, 1982 OR LICENSED SURVEYOR TO EXECUTED THIS STATEMENT.

COMMUNITY DEVELOPMENT DIRECTOR'S STATEMENT

I HEREBY CERTIFY THAT I HAVE EXAMINED THIS MAP AND HAVE FOUND IT TO BE SUBSTANTIALLY THE SAME AS IT APPEARED ON THE TENTATIVE MAP AND ANY APPROVED ALTERATION THEREOF AND COMPLIES WITH ALL APPLICABLE CITY ORDINANCES.

DATED _____
_____ COMMUNITY DEVELOPMENT DIRECTOR
CITY OF DIXON

SOLANO IRRIGATION DISTRICT STATEMENT

THE SOLANO IRRIGATION DISTRICT HEREBY CONSENTS TO THE PREPARATION AND RECORDATION OF THE FINAL [PARCEL] MAP OF _____. THE CERTIFICATION DOES NOT, UNLESS OTHERWISE INDICATED IN WRITING, CONSTITUTE A STIPULATION OR AGREEMENT AS TO AN AGREED BOUNDARY, AS TO THE CORRECTNESS OF THE SURVEY DATA INVOLVED ON THIS MAP, OR PERMISSION TO OCUPY OR UTILIZE ANY INTEREST IN REAL PROPERTY POSSESSED BY THE DISTRICT. SEPARATE WRITTEN AGREEMENTS MUST BE ENTERED INTO IN REGARD TO USE OF SUCH INTERESTS IN REAL PROPERTY.

DATED _____
_____ SECRETARY-MANAGER OR DIRECTOR
OF ENGINEERING
LICENSE: R.C.E.# _____
EXPIRES: _____

[PARCEL] [SUBDIVISION] [DEVELOPMENT] IMPROVEMENT AGREEMENT

THE [PARCEL] [SUBDIVISION] [DEVELOPMENT] IMPROVEMENT AGREEMENT WAS RECORDED ON _____, 20__, IN INSTRUMENT NO. _____, OFFICIAL RECORDS OF SOLANO COUNTY.

General Notes:

1. Approval by the City Engineer, or an authorized representative, is required prior to: (A) placing any concrete; (B) placing any aggregate base; (C) placing any asphalt concrete; and (D) backfilling trenches for pipe. Work done without such approval shall be at the Contractor's risk. Such approval shall not relieve the contractor from the responsibility of performing the work in an acceptable manner.
2. The types, locations, sizes and/or depths of existing underground utilities as shown on the improvement plans are obtained from sources of varying reliability. The Contractor is cautioned that only actual excavation will reveal the types, sizes, locations and depths of such underground utilities. The Project Engineer assumes no responsibility for the completeness or accuracy of the delineation of such underground utilities nor for the existence of other buried objects or utilities which are not shown on these plans. The Contractor is hereby notified that, prior to commencing construction, he/she is responsible for contacting the utility companies involved and requesting visual verification of the locations of their underground facilities shown on these improvement plans. The Project Engineer shall be notified by the Contractor of the scheduled time and place of such visual verification to enable said firm to have a representative present. Should a conflict become apparent, the Project Engineer will contact the parties responsible for relocation of the conflicting facility.
3. The contractor shall remove all obstructions, both above ground and underground, except as noted in Item 2 above, as necessary for the construction of the proposed improvements.
4. Where the Project Engineer, or his said representative, is to provide construction stakes, said firm will assume no responsibility whatsoever for improvements constructed therefrom unless the following procedure is observed by the Contractor: (A) the Contractor shall, through the office of the Project Engineer, request construction stakes for any particular phase of the work at least 48 hours prior to the planned use of said stakes. No request for stakes received from a contractor will be recognized unless a work order or authorization is received from that subcontractor; (B) where construction stakes are intended for use in setting concrete forms, the Contractor shall, upon completion of form setting, contact the Project Engineer to request a form check. If the grade and alignment of the forms are not approved, certain corrections will be requested prior to permitting concrete to be placed. A representative of the contractor must be present at the form check. No authorization will be given to a subcontractor.
5. Certain control points will be set by the Project Engineer, or a representative, which are critical to the construction staking of the project. These points will be designated at a pre-construction conference between representatives of the Project Engineer and the Contractor. The control points will be permanent monuments (rebar) set and clearly marked on the job site. The contractor shall not disturb the control points in any manner. If it becomes necessary to remove said control points during construction, the Contractor shall notify the engineer 48 hours in advance of said removal to allow for referencing said control points and their eventual replacement. If control points are removed or destroyed without said notification, the cost of replacement shall be deducted from the Contractor's payment and payment shall be made by owner to the Project Engineer.
6. The Contractor shall be responsible to prepare both pre and post construction corner records as required by Section 8700 (et seq.), of the State of California Professional Land Surveyor's Act for the preservation and protection of all existing survey monuments and other survey markers during construction. All such monuments or markers destroyed during construction shall be re-established at the Contractor's expense.

7. The site map is shown for general information only and is not intended to replace the detailed sheets elsewhere in this set of plans.
8. The City of Dixon is a member of the Underground Service Alert (U.S.A.) One-call program. The Contractor or any subcontractor for this contract shall notify members of
9. U.S.A. 2 working days in advance of performing any excavation work by calling the toll free number (800) 227-2600.
10. The Contractor shall expose existing sewer and drain lines for the Project Engineer to verify location and elevation prior to placement of pipe, where noted on the drawings. All costs of such excavation and backfill shall be included in the prices paid for various items of work.
11. The Contractor shall adjust all existing manholes and valve boxes within the work area to grade unless noted otherwise.
12. All materials and construction of public improvements shall conform to the latest edition of the City of Dixon Standard Specifications, unless otherwise shown on these plans or noted in the special provisions. All work shall conform to the Caltrans Standard Specifications, latest edition, except as modified herein.
13. The Contractor shall obtain the necessary encroachment permits from the City of Dixon or any other agencies having jurisdiction prior to commencing any work. Contractor shall be responsible for all Caltrans encroachment permits.
14. The Contractor shall notify the City of Dixon 48 hours prior to commencing work.
15. Contractor agrees that the Contractor shall assume sole and complete responsibility for job site conditions during the course of construction of this project, including safety of all persons and property. This requirement shall apply continuously and not be limited to normal and City working hours. The Contractor shall defend, indemnify and hold the owner and the Project Engineer harmless from any and all liability, real or alleged, in connection with the performance of work on this project, excepting for liability arising from the sole negligence of the owner or Project Engineer.
16. Stationing is taken from centerline distances, except as noted.
17. All gravity flow pipelines to be laid uphill from the lowest point starting at the end of existing improvements.
18. Prior to requesting a final acceptance of improvements, the engineer shall set survey monuments as shown in the Construction Details.
19. Underground facilities shall be installed prior to installation of curb, gutter, sidewalk, and aggregate base.
20. Castings collars for underground utilities shall be adjusted to 3/8 inch below finish grade by the underground Contractor (after completion of paving).
21. The Contractor shall provide the Project Engineer with a record of all field changes from these plans and the Project Engineer shall supply the City with mylar "as-built" and electronic plans upon completion of the project.
22. If unusual amounts of bone, stone or artifacts are uncovered, work within 50 meters of the area shall cease immediately and a qualified archaeologist shall be consulted to develop, if necessary, mitigation measures to reduce any archaeological impact to a less than significant effect before construction resumes in the area.
23. The Contractor is to verify depth and location of all existing utility stubs prior to installation of any pipe.
24. The Contractor shall be responsible for all excavation and shoring procedures and shall conform to the latest O.S.H.A. requirements.

25. The Contractor shall maintain an ongoing dust control program, including watering of open areas and/or placing soil stabilizer, in order to conform with the latest State and County air pollution regulations.
26. The Contractor shall maintain an ongoing process of removal of all spillage and tracking of excavation material on all paved streets.
27. The Contractor shall pursue the work in a continuous and diligent manner, conforming to all pertinent safety regulations, to ensure a timely completion of the project.
28. All dimensions and distances are to face of curb, curb return, face of building, face of wall, flow line, property line, center of striping, centerline of pipe or limits of improvements.
29. The Contractor shall, at all times during construction, protect from damage existing improvements on and around the site, including, but not limited to, pavement, curb and gutter, sidewalk, landscaping, signage, storm and sanitary sewer and all utilities. The Contractor shall assume sole responsibility for the repair of any improvements (existing or proposed) damaged throughout the course of construction.
30. All quantities shown herein are approximate and used for permit and bond purposes only. They shall not be used in any way for bidding or construction. It shall be the Contractor's responsibility to conduct quantity take-offs for bidding and construction purposes.
31. Ground profile is shown along centerline unless otherwise noted.
32. Prior to work on drawings that tie into existing facilities, the Contractor shall verify elevations shown. If elevations differ from that shown on the plans, adjustments to conform will be made by the Project Engineer.
33. When a utility pole is located in the proposed pavement section, this note shall be placed near the pole to be relocated: "No excavation work will occur within the street right-of-way prior to completion of utility pole relocation."
34. Contractor shall be responsible for conducting his/her operation entirely outside of any floodplain boundaries or "no grading areas." Floodplain boundaries shall be clearly delineated in the field prior to construction.
35. Where work is being done in an off-site easement, the Contractor shall notify the property owner 48 hours prior to commencing work.

Sewer Notes Vitrified Clay Pipe (V.C.P.):

1. It shall be the Contractor's responsibility to verify all sewer lateral locations with the Project Engineer prior to construction.
2. Contractor to expose end of existing sewer lines for surveyors to verify location and elevation prior to placement of pipe.
3. All sewer services shall have 5'-0" to 5'-6" of cover at the property line and 4'-0" cover at storm drain crossings. Water tight plugs shall be installed at the end of laterals and mains to be extended in the future. Installation shall be approved by the City prior to backfill.
4. Any sewer pipe having less than 20" of cover measured at the bell within the street before the addition of rock base shall be ductile iron pipe. All other pipe shall be V.C.P. conforming to A.S.T.M. C-700.
5. Cleanouts shall be installed 18" to 24" from the back edge of walk for all sewer service laterals. Services shall be extended 10 feet beyond the back of sidewalk. The cleanout shall have a screw tight plug with a box and lid.
6. The Contractor shall place an "S" in the wet concrete curb top at sewer lateral locations.
7. Use V.C.P. channel sections in all sewer transition manholes.
8. All sewer services to manholes shall match invert of the inlet pipe to crown of the outlet pipe, unless otherwise noted.

9. All sewer services to manholes shall be air tested to the satisfaction of the City Engineer after aggregate base and sidewalk placement and prior to placement of asphalt concrete. Services shall be ball and flushed and TV tested. Also, not less than 11 months after acceptance and prior to expiration of the one year warranty period, sewer mains and laterals shall be ball and flushed and TV retested. Contractor shall submit DVD disk and logs to the City after implementing any repairs required of retest.
10. Any water entering the sanitary sewer system to be constructed under these plans shall not be discharged into the existing system. Plugs must be installed in existing manholes as necessary to permit pumping the new system clear of water and debris prior to acceptance. Care shall be exercised in locating plugs to avoid interrupting service connections. Mortar or bricks must be used, inflatable devices are not satisfactory.
11. All manhole risers shall be sealed between rings with "Ramneck" or similar sealing material. Joints shall be grouted inside and out.
12. During installation and backfilling, all trenches shall be free of water. All dewatering shall be the responsibility of the Contractor or owner.
13. Sewer pipe shall be extra-strength, bell and spigot, unglazed vitrified clay pipe conforming to ASTM C-700.

Sewer Notes- (SDR 26) Poly Vinyl Chloride (P.V.C.) PVC Sewer Pipe shall not be installed without written approval by the City Engineer)

1. It shall be the Contractor's responsibility to verify all sewer lateral locations with the Project Engineer prior to construction.
2. Contractor to expose end of existing sewer lines for surveyors to verify location and elevation prior to placement of pipe.
3. Any sewer pipe having less than 20" of cover measured at the bell within the street before the addition of rock base shall be ductile iron pipe. All other pipe shall be V.C.P. conforming to A.S.T.M. D3034.
4. The Contractor shall place an "S" in the wet concrete curb top at sewer lateral locations.
5. All sewer services to manholes shall match invert of the inlet pipe to crown of the outlet pipe, unless otherwise noted.
6. All sewer services to manholes shall be air tested to the satisfaction of the City Engineer after aggregate base and sidewalk placement. Services shall be TV tested. Prior to expiration of the 1 year warranty period. Sewer mains and laterals shall be TV tested.
7. Any water entering the sanitary sewer system to be constructed under these plans shall not be discharged into the existing system. Temporary plugs must be installed in existing manholes as necessary to permit pumping the new system clear of water and debris prior to acceptance. Care shall be exercised in locating plugs to avoid interrupting service connections.
8. All sewer services to manholes shall match invert of the inlet pipe to crown of the outlet pipe, unless otherwise noted.
9. For all sanitary sewer systems, at the contractor's discretion, contractor may preform preliminary low pressure air testing from SSMH to SSMH. Exceptance low air pressure testing to the satisfaction of the City Engineer and in the presence of a City Public Works Inspector shall be performed after aggregate base, curb, gutter and sidewalk placement and prior to placement of Hot Mix asphalt. Services shall be ball and flushed and TV tested. Also, not less than 11 months after acceptance and prior to expiration of the one year warranty period, sewer mains and laterals shall be ball and flushed and TV retested. Contractor shall submit electronic copy and logs to the City after implementing any repairs required of retest.

10. Any water entering the sanitary sewer system to be constructed under these plans shall not be discharged into the existing system. Plugs must be installed in existing manholes as necessary to permit pumping the new system clear of water and debris prior to acceptance. Care shall be exercised in locating plugs to avoid interrupting service connections. Mortar or bricks must be used, inflatable devices are not satisfactory.
11. All manhole risers shall be sealed between rings with “Ramneck” or similar sealing material. Joints shall be grouted inside and out.
12. During installation and backfilling, all trenches shall be free of water. All dewatering shall be the responsibility of the Contractor or owner.
13. All leakage tests shall be completed and approved after backfilling and prior to placing of permanent surfacing.
14. All sewer mains and laterals shall be cleaned and flushed, deflection tested and air tested according to City of Dixon Standard Specifications.
15. The complete job site is ready for television inspection when the following work is completed:
 - a. All sewer pipelines are installed and backfilled.
 - b. All structures are in place, all channeling is complete and pipelines are accessible from structures.
 - c. All other underground facilities, utility piping and conduits are installed.
 - d. Final street subgrading is complete and ready for asphalt concrete surfacing. Pipelines to be inspected have been preliminarily balled and flushed or cleaned with a high pressure cleaner.
 - e. Final air tests have been completed and approved. When the above items are complete, the Contractor shall notify the City in writing as to the scheduled date of the television inspection and the inspection shall be completed per the City of Dixon Standard Specifications.
16. All sewer laterals are to use ABS cleanouts.
17. All laterals and mains are to be video taped to the service cleanout.

Storm Drain Notes:

1. The Contractor shall maintain all existing drainage facilities and provide necessary erosion control measures within the construction area until the drainage improvements are in place and functioning. If requested by the City Engineer, the Contractor shall provide an erosion control plan to the City for approval.
2. Unless otherwise noted on the plans, all reinforced concrete pipe (RCP) shall be A.S.T.M. C76 Class III. Cast-in-place non-reinforced concrete pipe (CIPP) shall conform with Caltrans Standard Specifications Section 63 with the following additional requirements: (1) concrete shall be 3,500 psi. minimum 28 day compressive strength; (2) portland cement shall be Caltrans Type II modified; and (3) backfill shall comply with the project specifications.
3. Install weak concrete plug at all storm drain stubs.
4. Manhole barrel sections to be grouted inside and outside.

Water System Notes:

1. All materials and installation of the City of Dixon water distribution system shall be in accordance with the City’s Engineering Standards and Specifications, latest revisions.
2. The Contractor shall be responsible for locating and verifying all existing utilities.
3. Water mains shall be PVC C-900 Class 150 and shall be laid in separate trenches with a minimum horizontal separation of 10 feet and a minimum vertical separation of 1 foot.

4. All sectionalizing valves shall be butterfly valves and conform to the applicable provisions of AWWA C-504. All butterfly valves shall be flanged (short body) and not of the wafer type, with a pressure rating equivalent to that of the pipeline. Refer to City standards for coating requirements.
5. Contractor shall use PVC pipe for valve box depth extensions.
6. The Contractor shall place a "W" in the wet concrete curb top for water service locations.
7. Contractor shall notify the City of Dixon at (707)678-7030, 48 hours prior to the inspection of the water system.
8. Provide five copies of shop and fabrication drawings to the City of Dixon for review and approval.

Grading Notes:

1. Grading shall include all labor, materials and equipment necessary to construct grades as shown on the grading plan. No additional compensation will be allowed for the disposal of excess excavation placed at the direction of the Project Engineer in advance of any changes deemed necessary to obtain a balanced grading program to meet minimum standards. Minimum compaction outside the street right-of-way shall be 90 percent.
2. All grading shall be completed in accordance with the recommendations of the preliminary soils report.

Erosion and Sedimentation Control Notes: Notes shall be on the Erosion Control Plan (or on the Grading Plan if no separate Erosion Control Plan), addressing the following. All plans shall be in compliance with the City of Dixon's approved NPDES permit and annual Best Management Practice (BMP) listing. For additional information contact the City Engineer.

1. Erosion and sediment control measures shall be effective for the duration of control activity.
2. No storm runoff water shall be allowed to drain directly into the existing underground storm system before the on-site storm drain system is installed.
3. As soon as practical after the new on-site system is installed, the catch basins shall be installed and straw bales or approved screens shall be placed around the catch basins, as shown on City Standard Details. The Contractor shall have an option to install prefabricated frames with filter fabric attached to the front of the drain inlet and extended 12 inches on each side of the drain inlet opening. Frame shall be approved by the City Engineer and shall fit the opening with less than one-quarter inch gap at any one point.
4. Should the proposed on-site storm system not be installed by October 15, temporary sediment basins shall be constructed around the opening of any existing storm pipes that drain the site, per City Standard Details or per a special detail shown on the plan.
5. The name, address and 24-hour telephone number of the responsible person for implementation of erosion and sedimentation control plan shall be provided.
6. A minimum of 50 linear feet by 12 feet width of drain rock, 1-1/2" diameter or larger at a minimum depth of 6", shall be installed at each site ingress/egress. This does not need be done at ingress/egress locations, which will be closed by immovable barricades during construction.
7. All erosion and sedimentation control measures shall be maintained until disturbed areas are stabilized. Changes to the Erosion and Sedimentation Control Plan shall be made to meet field conditions, but only with the approval of or at the direction of the City Engineer.
8. During the rainy season as specified in Note # 1, all sidewalk and paved areas shall be kept clear of earth material and debris. The site shall be maintained so as to minimize sediment laden runoff from entering any storm drainage system.

9. The Erosion and Sedimentation Control Plan covers only the first winter during which construction is to take place. Plans are to be resubmitted prior to September 1 of each subsequent year until the City accepts the site improvements.
10. The Contractor shall be responsible to inspect and repair all erosion control facilities at the end of each workday during the rainy season.
11. The Contractor shall be responsible to clean out sediment basins whenever the level of sediment reaches the sediment clean out level indicated on the plans.
12. The Contractor shall be responsible to protect borrow areas and/or stockpiles with appropriate erosion control measures satisfactory to the City Engineer.
13. The cleaning of paved streets, during and at the completion of construction, shall be performed with mechanical sweepers. The use of water trucks to “wash down” the street is prohibited.
14. The Erosion and Sedimentation Control Plan, details, notes and calculation if required, must be a part of the plan check submittal package for either Grading Permit only or Final Site Approval. The Design Engineer prior to plan preparation should consult the City Engineer if the need for a separate plan is in doubt.

Street Lighting Notes:

1. Street lighting luminaires shall be 120 volt high pressure sodium with semi-cutoff Type III light distribution.
2. Street lighting Contractor shall be responsible for contacting all utilities companies and/or utility districts as to location of underground facilities.
3. Street light foundation cap shall be installed square to sidewalk with 2 percent slope toward the street.

Street Notes:

1. Public safety and traffic control shall be provided in accordance with the Standard Specifications and as directed by the City Engineer. Safe vehicular and pedestrian access shall be provided at all times during construction.
2. When street work or trenching is done that would interfere with emergency response traffic, the Contractor shall obtain an Encroachment Permit from the City of Dixon, submit a traffic control plan, and notify the Fire and Police Departments 24-hours in advance of the time and location of such closures. The Contractor shall again contact these departments as soon as the street is reopened.
3. Unless specifically set forth in the Special Provisions, all marked lanes of traffic shall be open on all major streets in each direction during the peak traffic hours of 7:00 am to 8:00 am and 3:00 pm to 5:00 pm. A traffic lane shall be considered open if it is surfaced with asphalt and is at least 10 feet wide.
4. Whenever a work zone is within 10 feet of a traffic lane and there is a pavement cut, ditch or trench greater than 2 inches deep, the Contractor shall maintain continuous barricades spaced at approximately 50 foot intervals. If the cut, ditch or trench is more than 10 feet from a travel lane, the spacing may be greater, but not to exceed 200 feet.
5. Prior to ordering street name signs, the Contractor shall verify street names and street sign specifications with the City Engineer.
6. The Contractor shall remove, temporarily relocate and reinstall all public signs, private signs and mailboxes in conflict with the construction. Mail box locations shall be as approved by the United States Postal Department. Public sign relocation shall be coordinated with the sign owners and the City of Dixon.

SUBDIVISION NO., XXXX
PROJECT NAME
ENGINEER
DATE

ENGINEER'S STATEMENT
(OR)
SURVEYOR'S STATEMENT

CITY ENGINEER'S STATEMENT

SOLANO IRRIGATION DISTRICT
STATEMENT

CITY CLERK'S STATEMENT

COMMUNITY DEVELOPMENT DIRECTOR'S
STATEMENT

COUNTY TAX COLLECTOR'S STATEMENT

COUNTY RECORDER'S STATEMENT

OWNER'S STATEMENT

NOTARY PUBLIC

TRUSTEES STATEMENT

NOTARY PUBLIC



CITY OF DIXON
ENGINEERING
DESIGN STANDARD



Approved: March 2022

TYPICAL STATEMENT
SHEET LAYOUT

FIG.
2-1

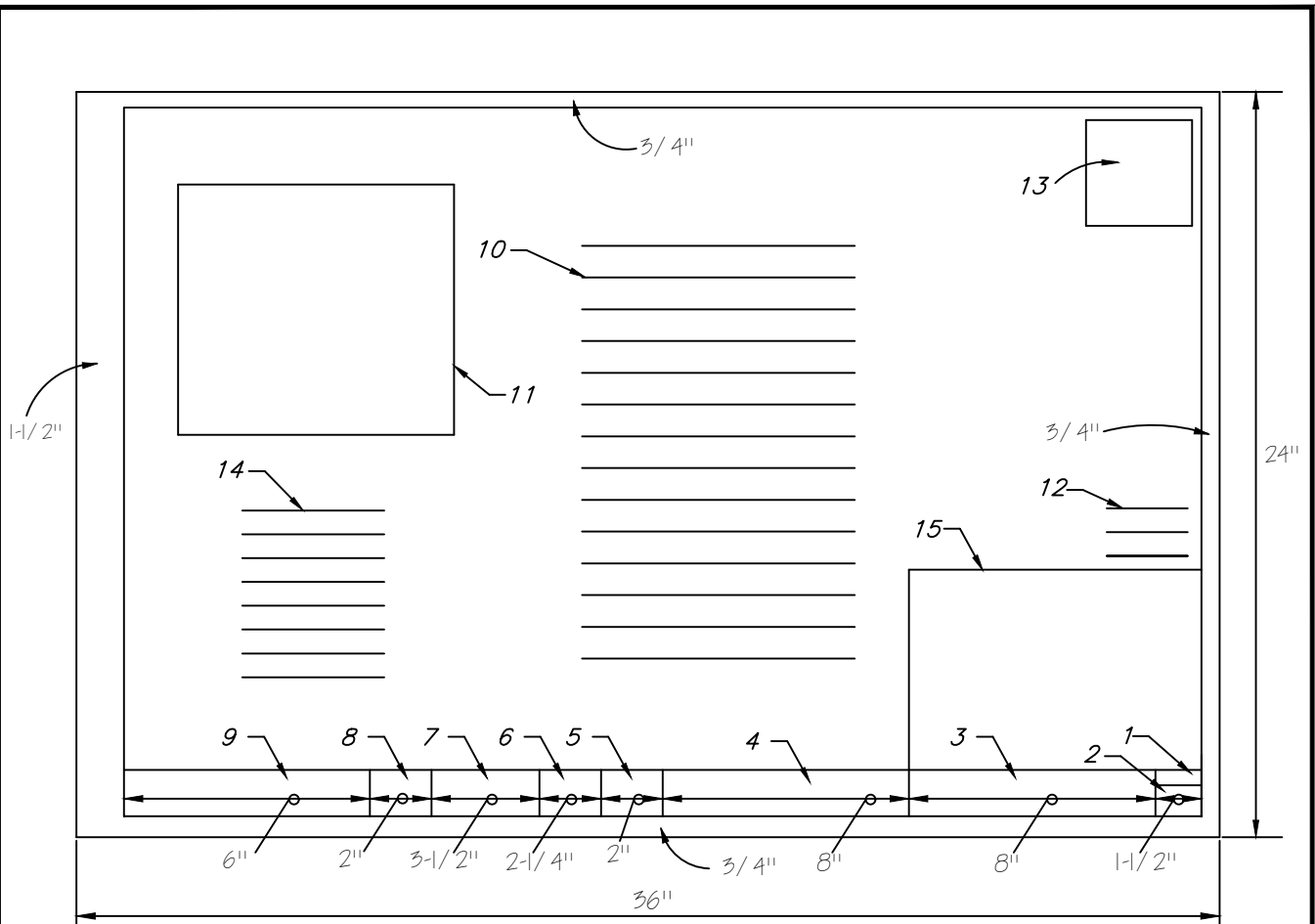

1. Date: Month & Year
2. Sheet No. X of X.
3. Project title and sheet description.
4. Private engineers title block including company name and emblem, address, phone no., fax no. and email address if applicable.
5. Registered civil engineer stamp with license no. and expiration date.
6. Drawing initials: computed by:, drawn by:, designed by: and proj. eng.:
7. Bench mark.
8. Drawing scale.
9. Revision block.
10. Construction notes, if space exists.
11. 100 scale index map with:

A. Tract boundaries	E. Existing improvements to be joined.
B. Lot lines	F. Index of sheets
C. All streets with names	G. North arrow and scale
D. All improvements	
12. Soils engineers name, address, date of report.
13. Location map.
14. Legend and abbreviations.
15. Approval block with signature blocks for City Engineer
 City Engineer block shall state: "Reviewed and accepted for public improvements in public rights-of-way and in public easements on private property. The City Engineer has not reviewed and is not responsible for any on-site improvements."

FIG.
2-2

TYPICAL TITLE SHEET
FOR
IMPROVEMENT PLANS



Approved: March 2022

CITY OF DIXON
ENGINEERING
DESIGN STANDARD



STREET LEGEND	EXISTING	PROPOSED
SIDEWALK, VERTICAL CURB & GUTTER WITH DRIVEWAY		
SIDEWALK, LOW PROFILE CURB & GUTTER		
BACK EDGE OF WALK ELEVATION		
GRADE ELEVATION		
PROPERTY LINE		
RIGHT-OF-WAY		
EASEMENT		
STREET CENTERLINE		
SURVEY MONUMENT		
NO ACCESS		
FENCE		
TREE		
STREET LIGHT		
POLE TOP STREET LIGHT		
UTILITY POLE		
TRAFFIC SIGNAL HEAD		
PEDESTRIAN HEAD		
SERVICE PEDESTAL		
CONTROLLER		
PULL BOX		



CITY OF DIXON
ENGINEERING
DESIGN STANDARD



Approved: March 2022

TYPICAL LEGEND

FIG.
2-3A

SEWER LEGEND	EXISTING	PROPOSED
SEWER MAIN LINE (SHOW SIZE AND DIRECTION OF FLOW)		
SERVICE WYE AND LATERAL		
MANHOLE		

WATER LEGEND		
WATER MAIN (SHOW SIZE)		
VALVE		
FIRE HYDRANT		
BLOW OFF		
CHECK VALVE		

STORM DRAIN LEGEND		
STORM DRAIN MAIN LINE (SHOW SIZE AND DIRECTION OF FLOW)		
GRATE INLET/ Type A		
CURB INLET/ Type B		
FIELD INLET		

MISCELLANEOUS		
REMOVE EXISTING IMPROVEMENTS		
PAVEMENT OVERLAY		
NEW PAVEMENT		

FIG. 2-3B	TYPICAL LEGEND		CITY OF DIXON ENGINEERING DESIGN STANDARD
		Approved: March 2022	

ENGINEERING DESIGN STANDARDS

SECTION 3 – STREET DESIGN

DS3-01. STREET CLASSIFICATIONS: For the purposes of geometric and structural design, streets shall be classified according to the following requirements. Street classifications shall be based on land use frontage and proposed cumulative traffic volumes to maintain an acceptable Level of Service.

Alleys are not permitted unless specifically approved by the City Council.

New Alley – A 23’ wide travel way/ right-of-way and 6’ Public Service Easement (PSE) each side, depressed in the center with concrete valley gutter.

Existing Alley- A 20’ wide travel way/ right-of-way, depressed in the center.

Cul-De-Sac – A street terminated with a bulb with only one public entrance/exit. See DS3-07 for additional details.

Local Street – A street servicing 100 or fewer residential lots between beginning and ending points and providing access from the residential lots to minor collectors.

Minor Collector – A residential street servicing more than 100 residential lots or along which schools or parks are proposed to front and providing access from local streets to major collectors.

Major Collector – A street servicing a commercial subdivision or a residential entrance providing access from minor collectors and arterials to other arterials. No residential frontage (driveways) will be permitted along major collector streets.

Industrial Collector - A street servicing a development of primarily industrial land uses.

Arterial – A street leading to and from an Interstate Freeway (I-80) interchange or State Highway (SR113/ North First Street) to major traffic attractions, such as the downtown business district; major residential, commercial or other industrial areas; or traversing the entire city limits.

DS3-02. STRUCTURAL SECTIONS:

The design of the pavement structural section for all streets shall be based on the Traffic Index (T.I.) as shown in Table 3-1, and the “R” Value (Resistance Value) as determined by Test Method No. California 301. If soils tests are not available, a minimum R-Value of 5 shall be used. T.I. values listed in Table 3-1 may be raised by the City Engineer if actual/projected traffic volumes and/or percentage of trucks warrant higher values.

**TABLE 3-1
TRAFFIC INDEX VALUES**

Arterial		Collector		Local	Industrial
SR-113	City	Major	Minor		
*	10 *	8 *	7	6	10 *

*A classification count shall be conducted and 20-year T.I calculated and approved by the City Engineer.

The thickness of the various structural components will be determined by the tables, charts, formulas and procedures contained in the “Caltrans Highway Design Manual,” or as directed by the City Engineer. The safety factor, as shown in the Design Manual, shall be used when designing pavement section(s) for Traffic Indices of 8 and above. The structural section for local streets shall be a minimum of 3 ½ inches of asphalt concrete and 10 inches of aggregate base over engineering fabric per Section 88 of the State Standard Specifications. A pavement structural section design based on a soils report is required for arterial, collector and industrial streets. For collectors the minimum asphalt section shall be 4 ½ inches and for arterials and industrial streets the minimum asphalt section shall be 6 inches.

The soils report shall include a map of the subject area showing proposed and existing streets, contours, locations of the test samples, “R” value results and the proposed structural pavement sections. The report shall be signed by a registered civil or geotechnical engineer and shall be bound in an 8-1/2” x 11” format.

DS3-03. PROFILE STANDARDS:

The minimum longitudinal gutter slopes on all new streets shall be 0.35 percent. The minimum longitudinal gutter slopes through all curb returns and cul-de-sac bulbs shall be 0.50 percent. The maximum longitudinal grade on new streets shall not exceed 5.0 percent unless approved by the City Engineer.

Standard cross slope on new streets shall be 2.0 percent.

When an existing street is widened, the minimum cross slope shall be 1.5 percent and the maximum cross slope shall be 4.0 percent. The cross slope of the widening shall not be less than the cross slope of the existing pavement.

When two streets intersect, neither street shall have a grade greater than 3.0 percent for a minimum distance of 40 feet measured from the curb line of the intersecting street.

Vertical Curves – The minimum vertical curve length allowable at the intersection of two grades shall be 50 feet. Vertical curves on local and collector streets may be omitted where the algebraic difference in grades does not exceed 2.0 percent. The minimum vertical curve data to be computed and shown on the plans shall consist of the point of intersection elevation, the tangent gradients, the middle ordinate and the length of curve.

Design Speed – The typical design speed shall be 30 mph for local streets, and 35 mph for minor collector streets, and 45 miles per hour for major collector streets. The City Engineer shall be consulted for design speeds of arterial streets.

DS3-04. STREET GEOMETRICS: Table 3-2 summarizes the street widths, intersection radii, and horizontal curvature radii associated with the different street classifications.

DS3-05. PARTIAL STREETS: Partial streets may be permitted by the City Engineer along the boundary of a subdivision or property of the development where the ultimate right-of-way cannot be obtained or where the entire street width cannot be constructed.

The minimum right-of-way width shall be one-half of the ultimate right-of-way, or additional width to provide a minimum of 32 feet of pavement. When partial streets are constructed, parking will be considered only adjacent to curb, gutter. All other areas shall be posted “NO PARKING.”

When only a portion of a street is constructed, the edges of the new pavement not adjacent to curb and gutter shall be protected by the use of 2”x6” redwood headers, construction grade, and 24” redwood stakes at 4 feet centers. Asphalt concrete dikes, extruded concrete curbs or 2-foot-wide compacted aggregate base shoulders shall be placed at the edge of pavement.

DS3-06. INTERSECTION SPACING: Table 3-3 summarizes minimum acceptable intersection spacing between local, collector and arterial streets.

DS3-07. CUL-DE-SAC: Local (residential) cul-de-sac streets shall be terminated with a bulb which shall have right-of-way and curb radius dimensions conforming to Figure 3-1. Commercial and industrial cul-de-sacs shall have a minimum curb radius of 50 feet. No cul-de-sac shall exceed 600 feet in length measured from the centerline of the connecting street to the radius point of the cul-de-sac.

DS3-08. ELBOW INTERSECTION: Right angle elbow intersections shall be avoided. Upon approval of the City Engineer, they may be permitted and designed in accordance with Figure 3-1.

TABLE 3-2 STREET GEOMETRICS
(REFER TO FIG. 3-4A – 3-4I)

Classification	Street Width		Intersection Radii ¹		Horizontal Curve Radii
	Curb Face to Curb Face	Right-of-Way	Curb Face	Right-of-Way ²	Centerline (Minimum)
Local & Local w/Cul-de-Sac	36 Feet ³	37-48 Feet	30.5 Feet	24 Feet	300 Feet
Collector					
Minor ⁶	40 Feet	53 Feet	35 Feet	Varies	500 Feet
Major	53-67 Feet	54-116 Feet ⁴	40 Feet	Varies	500 Feet
Industrial ⁵	48 Feet	49 Feet	50 Feet	Varies	350 Feet
Arterial					
City	80 Feet	81-133 Feet	50 Feet	Varies	800 Feet
SR113	80 Feet	81-133 Feet	50 Feet	Varies	

¹ Where streets of differing classification intersect, the greater radius requirement shall prevail.

² Right-of-way radii at intersections with arterial and/or collector streets shall be designed with a 45 degree chord at the back edge of walk to provide for a 4-foot-wide sidewalk platform behind the curb ramps.

³ Low-profile and rolled curb, gutter and sidewalk, 1 foot from back of sidewalk (approx. flowline).

⁴ Width dependent on residential backing and/or landscape strip designations.

⁵ Typically, sidewalk on industrial streets will be installed on one side of street.

⁶ When bike lanes are mandated, an additional 10' right-of-way and pavement shall be required.

DS3-09. CENTERLINE RADIUS: Street centerlines shall intersect one another at an angle as near to the right angle as possible by tangents not less than 100 feet in length, unless otherwise approved by the City Engineer. Minimum centerline curve radii for the various street classifications are shown in Table 3-2. Sight distances shall be designed for the design speed of the street per Section DS3-03 (G), DS3-10 and Figures 3-3A, 3-3B and 3-3C. The curve data (delta angle, length, tangent, radius, chord distance and chord bearing) for all centerline curves shall be computed and shown on the plans. Special consideration will be given to unusually difficult alignment problems

TABLE 3-3

Intersection Roadway Classifications	Minimum Acceptable Intersection Spacing From Adjacent Intersections
Local with Local	150 Feet
Local or Minor Collector with Minor Collector	200 Feet
Minor Collector or Major Collector with Major Collector	660 Feet
Major Collector with Arterial	1,000 Feet*
Arterial with Arterial	1,000 Feet*

*- This condition does not apply where a raised median is provided on arterial streets to separate conflicting movements. Blocks must be a minimum of 500 feet in length.

DS3-10. SIGHT DISTANCE AT INTERSECTIONS: Streets shall not be designed with intersections on the inside of curves or at any location in general where sight distance will be inadequate for drivers, bicyclists, or pedestrians to determine if they can safely enter the traffic flow or cross the street. Street alignments may require individual designs based on State of California, Department of Transportation standards.

The minimum required sight distance at stop sign locations is calculated by locating a point 15 feet back from the through street’s curb line and 3 feet to the right of the centerline of the cross street (where a driver’s eyes would typically be following a legal stop behind the stop bar) and extending a “line of sight” to the most dangerous position of an approaching vehicle. This distance, which varies with the design speed of the through street, is shown on Figure 3-3A. Refer to Figures 3-3B and 3-3C for specific sight distance requirements.

DS3-11. INTERSECTION WIDENING: Street right-of-way widths are to be increased in accordance with Figure 3-2 at the following intersections: (1) any two arterial streets; (2) an arterial street and a major collector street; and (3) any two major collector streets, as directed by the City Engineer.

DS3-12. SIDEWALKS: Sidewalk widths are measured from the back of curb to the back of walk. All sidewalks adjacent to arterial, major collector streets and in commercial areas shall be a minimum of 8 feet wide. Sidewalks on minor and industrial collectors shall be 6 feet in width. Sidewalks on local streets shall be 5 feet. The typical width for meandering sidewalks shall be a minimum of 8 feet and if sidewalk serves as a bike path, sidewalk shall be a minimum of 10 feet. When a sidewalk is adjacent to a fence, soundwall, building, or vertical landscaping, an additional 2 feet of width shall be added.

DS3-13. CURB AND GUTTER: Low-profile curb and gutter shall be installed on local streets in accordance with Construction Detail 3010. Vertical curb and gutter shall be installed on collector, arterial, and industrial streets in accordance with Construction Detail 3000. The transition from low-profile curb to vertical curb shall be in accordance with Construction Detail 3050.

DS3-14. CURB RAMPS: Accessible curb ramps shall be constructed at all street intersections in accordance with the appropriate Construction Details 3140, 3150, 3160, 3170, and 3180 and at other locations where required by the City Engineer. Ramps shall be located at the midpoint of the curb return at intersections. Type II accessible curb ramps Standard Detail 3150 shall be constructed at all residential intersections unless otherwise approved by the City Engineer.

DS3-15. DRIVEWAYS:

All driveways shall intersect streets perpendicular to the centerline of the street. Driveways on cul-de-sacs shall intersect radially to the center point.

Driveways are not permitted within the curb returns of an intersection.

Driveways intended for single-family residential usage shall be designed in accordance with either Residential Driveway Detail 3070 when vertical curb is used or Residential Driveway Separated Sidewalk Detail 3090 when separated sidewalk is used. All other driveways shall be designed according to the Commercial Driveway Detail 3100 or the Industrial Driveway Detail 3120. The City Engineer may require/allow greater widths for developments with high traffic generation.

When on-site driveways are abandoned or relocated, the concrete driveway sections in the public right-of-way shall be removed and replaced with curb, gutter and sidewalk to match existing improvements.

Where possible, driveways shall not be located on the inside of curve. Accessible curb ramps shall not be utilized as driveway approach.

DS3-16. EASEMENTS: A Public Service Easement (PSE) used for utility company improvements, streetlights, fire hydrants, and street signs shall be dedicated to the City and shall be located adjacent to the right-of-way as shown in Figures 3-4A through 3-4I.

DS3-17. VALLEY GUTTERS: Valley gutters at driveways are allowed in special circumstances and require the written approval of the City Engineer (See Construction Detail 3060).

DS3-18A. NEW ALLEY WAY: A new alley shall be no less than 23 feet in width with a minimum slope of 2 percent from the outside edge to the center with a 3' wide concrete valley gutter constructed at its center similar to Construction Detail 3060. The typical alley (Type 1) structural section shall be 3 ½ inches of asphalt concrete and 10 inches of Class II aggregate base(See Construction Detail 3190).

DS3-18B. EXISTING ALLEY WAY: An alley shall be no less than 20 feet in pavement width with a minimum slope of 2 percent from the outside edge to the center. The typical alley (Type 1) structural section shall be 3 ½ inches of asphalt concrete and 10 inches of Class II aggregate base. An alternative (Type 2) section of 8 inches concrete over 6 inches Class II aggregate base may be utilized (See Construction Detail 3190). A City standard alley apron shall be provided at the street entrance (See Construction Detail 3200). Parking shall not be allowed in the alley unless adequate additional width is provided.

DS3-19. MAINTENANCE ROADS: Roads designed for maintenance access to storm drainage ponds, remote facilities, or for fire apparatus access shall have a typical right-of-way width of 24 feet and a minimum roadway width of 12 feet. The typical structural section shall be 8 inches of Class II aggregate base on geotextile fabric. When required by the City Engineer, 3" of asphalt concrete over 8 inches Class II aggregate base shall be placed. As required by the Fire Marshall, maintenance roads shall be constructed with 60 feet by 20 feet wide turnouts, including shoulders, at 300 feet intervals.

DS3-20. STREET NAMES: New streets shall be named in accordance with the City of Dixon Subdivision Ordinance. Streets shall be named with an appropriate suffix designation such as "Avenue,"

“Drive,” “Way,” “Street,” or “Lane.” Cul-de-sac streets shall be named with “Court” or “Place” as the only acceptable suffixes.

DS3-21. STREET NAME SIGN LOCATIONS: Two street name sign installations with two sign plates on each pole are required at each four-way intersection. The installations shall be located on both far right-hand corners of the intersection relative to the street having the greater right-of-way width or relative to the more important street if right-of-way widths are equal. Street name signs can usually be installed above stop signs on the same post (See Construction Detail 3240). Additional street name signs may be required where a street changes names at the intersection.

At “Tee” intersections, the street name sign shall be mounted on the streetlight standard located at the prolongation of the intersecting street’s centerline, when possible. For situations where a streetlight cannot be utilized, signs shall be placed at the far right-hand corner of the intersection relative to the through street. At elbow intersections, the sign installation shall be located behind the sidewalk at the midpoint of the inside curb return.

Street names and street name sign size and locations shall be shown on the improvement plans and meet the following standards:

General:

- Street name signs will be 9” wide by 30”, or 36” long (Depending on the length of the street name).
- The sign will be Green with white lettering with a white boarder.
- No arrows, block numbers, or pictographs will be allowed on the sign.
- The sign will be made of DG3 (diamond grade) reflective sheeting.
- The sign will be .125 aluminum.

Lettering:

- Lettering shall be composed of a combination of lower-case letters with initial upper-case letters.
- Lettering of initial upper-case letters at least 6 inches in height and lower-case letters at least 4.5 inches in height.
- The City Standard Font is HWY GOTIDC MOD C.
- North, South, East, and West streets will be abbreviated with an upper-case corresponding abbreviation followed by a period (i.e., N. S. E.W.)
- Streets that are named after a letter of the alphabet will have the direction spelled out using the criteria above, and no period will be placed following the letter of the street (i.e., West B St compared to W. Walnut St or East D St. compared to N. Second St).
- Abbreviations for type of street are listed in the table below (first letter upper-case and the following letters lower-case):

TABLE 3-4

Avenue	Ave
Boulevard	Blvd
Circle	Cir
Court	Ct
Drive	Dr
Lane	Ln
Parkway	Pkwy

Place	Pl
Road	Rd

Examples:

- N. Almond St
- Parkway Blvd
- Diane Pl
- Pitt School Rd
- N. Second St
- Marvin Way
- MacDonald Ct
- Gateway Dr
- Market Ln
- E. Creekside Cir
- Stratford Ave
- West A St

Intersections with arterial and major collector streets will require advance street name signs. Signplacement for these locations shall be at the direction of the City Engineer.

DS3-22. TYPICAL TRAFFIC SIGNS: The following is a summary of the installation requirements of signs typically associated with development projects. Additional signs may be required by the City Engineer.

“Stop”: Locations shall be established in accordance with the City of Dixon “Policy and Warrants for Stop and Yield Signs.” All stop signs shall be installed as directed by the City Engineer contingent upon an authorizing City Council resolution. Stop signs shall be 30” octagonal shaped where approach speeds are less than 45 mph and shall be 36” octagonal where approach speeds are 45 mph or greater.

“Dead-End” and “No Outlet”: All single roads or streets that terminate in a dead-end or cul-de sac where it is not immediately apparent to the driver that no other streets can be accessed from road shall be posted with a standard code W14-1 (“Dead-End”) sign. The standard location for the W14-1 sign is on the right-hand side at the curb return or at the first property line. The “No Outlet” signs shall be posted at the entrance to a road or road network from which there is no other exit.

“No Parking”: All restricted parking signs and markings shall be installed as directed by the City Engineer upon authorization by City Council resolution.

DS3-23. SIGNING AND STRIPING: Signing and striping shall conform to the California Department of Transportation and City of Dixon requirements. Bikeways shall be delineated according to the City of Dixon Bikeway Plan on file at the City of Dixon Engineering Department. A signing and striping plan shall be submitted as part of the improvement plans for City Engineer’s approval. This plan may be combined with the street lighting plan when clarity can be maintained.

DS3-24. PERMANENT BARRICADES: A standard end of street barricade shall be constructed where improvements are temporarily terminated but are proposed for extension in the future. The barricade shall extend completely across the right-of-way and be constructed in accordance with Construction Detail 3260.

A standard sidewalk barricade shall be constructed across the end of a sidewalk where pedestrians cannot safely continue beyond the end of the sidewalk. Sidewalk barricades are not required when a standard street barricade will be installed across the entire right-of-way block the sidewalk. Sidewalk barricades shall conform to Construction Detail 3250.

Signs and barricades, in accordance with Construction Detail 3270, are required where partial street widening occurs.

CROWN TO HAVE 2% GRADE
HIGH POINT OF PAVEMENT EDGE

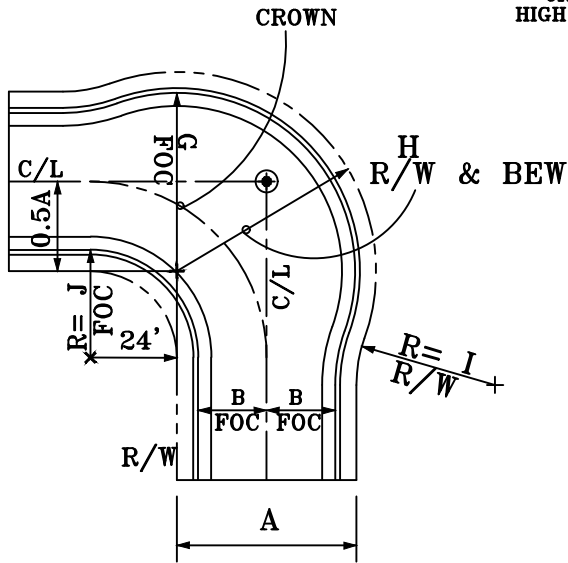

EXPANDED CORNER

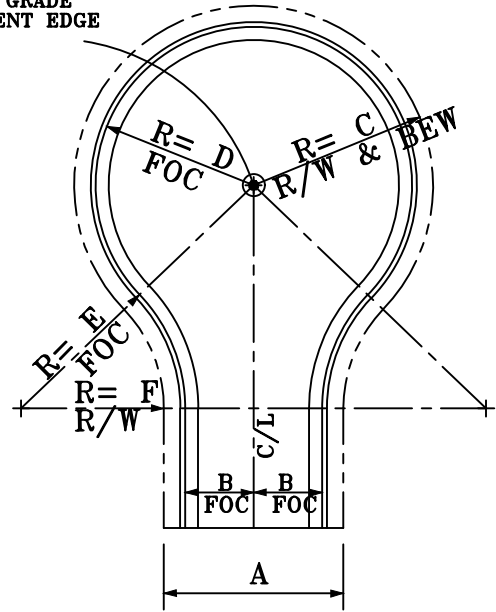

CUL-DE-SAC

		Street R/W A	Street C/L to FOC B	BULB R/W Radius C	BULB FOC Radius D	Reverse Curvature FOC Radius E	Reverse Curvature R/W Radius F
CUL-DE-SAC	Residential	48'	18'	50'	44'	36'	30'
	Commercial	Varies*	25'	60'	54'	50'	44'
	Industrial	Varies*	25'	60'	54'	50'	44'
OFFSET CUL-DE-SAC	Residential	47'	17.5'	50'	44'	30'	24'
	Commercial	Varies*	25'	60'	54'	50'	44'
	Industrial	Varies*	25'	60'	54'	50'	44'

Varies* - Depends on sidewalk width of 0', 6' or 8'.

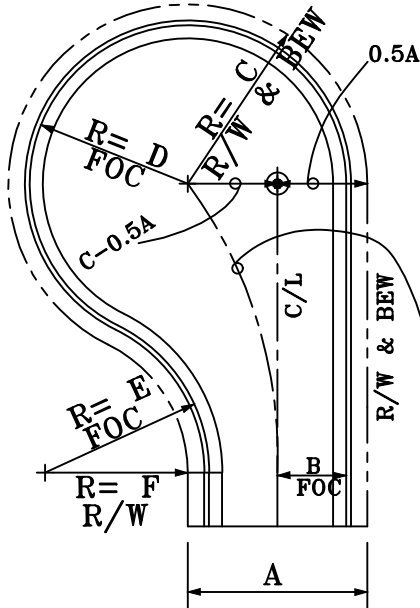

OFFSET CUL-DE-SAC

		Street R/W A	Street C/L to FOC B	Expanded Corner FOC Radius G	Expanded Corner R/W Radius H	Expanded Corner R/W Radius I	FOC J
EXPANDED CORNER	Residential	48'	18'	46'	52'	30'	30'
	Commercial	Varies*	25'	70'	76'	44'	50'
	Industrial	Varies*	25'	70'	76'	44'	50'

Varies* - Depends on sidewalk width of 0', 6' or 8'.

CROWN TO HAVE 2% GRADE. HIGH POINT TO PAVEMENT EDGE.

- ⊙ - MONUMENT
- FOC - FACE OF CURB/ FLOW LINE
- BEW - BACK EDGE OF WALK
- R/W - RIGHT-OF-WAY
- C/L - CENTERLINE
- R - RADIUS
- NA - NOT APPLICABLE

NOTE: LOW-PROFILE CURB & GUTTER TYPICAL FOR RESIDENTIAL STREETS.



CITY OF DIXON
ENGINEERING
DESIGN STANDARD



Approved: March 2022

CUL-DE-SAC
EXPANDED CORNER

FIG.
3-1

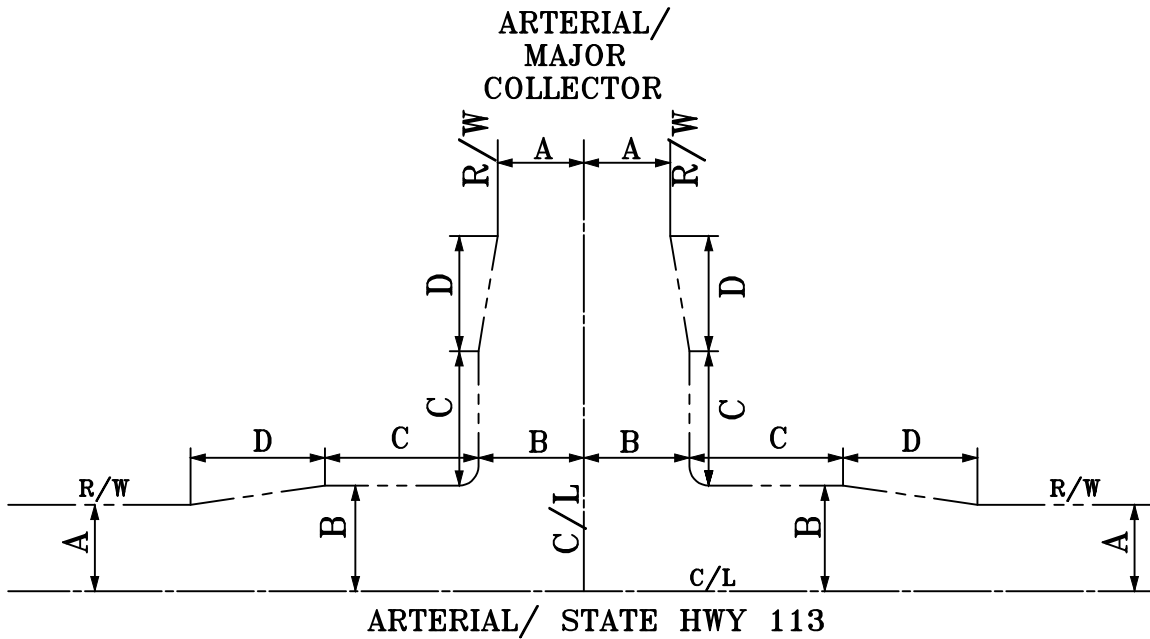

DIMENSIONS

	A	B	C	D
MAJOR COLLECTOR	*	A+12'	175'	120'
ARTERIAL (CITY)	*	A+12'	175'	120'
STATE HWY **	50'	A+12'	175'	120'

* REFER TO TABLE 3-2 OF THESE STANDARDS.
 ** REQUIRES CALTRANS APPROVAL.

FIG.
3-2

WIDENING DETAILS
AT MAJOR STREET
INTERSECTION



CITY OF DIXON
ENGINEERING
DESIGN STANDARD



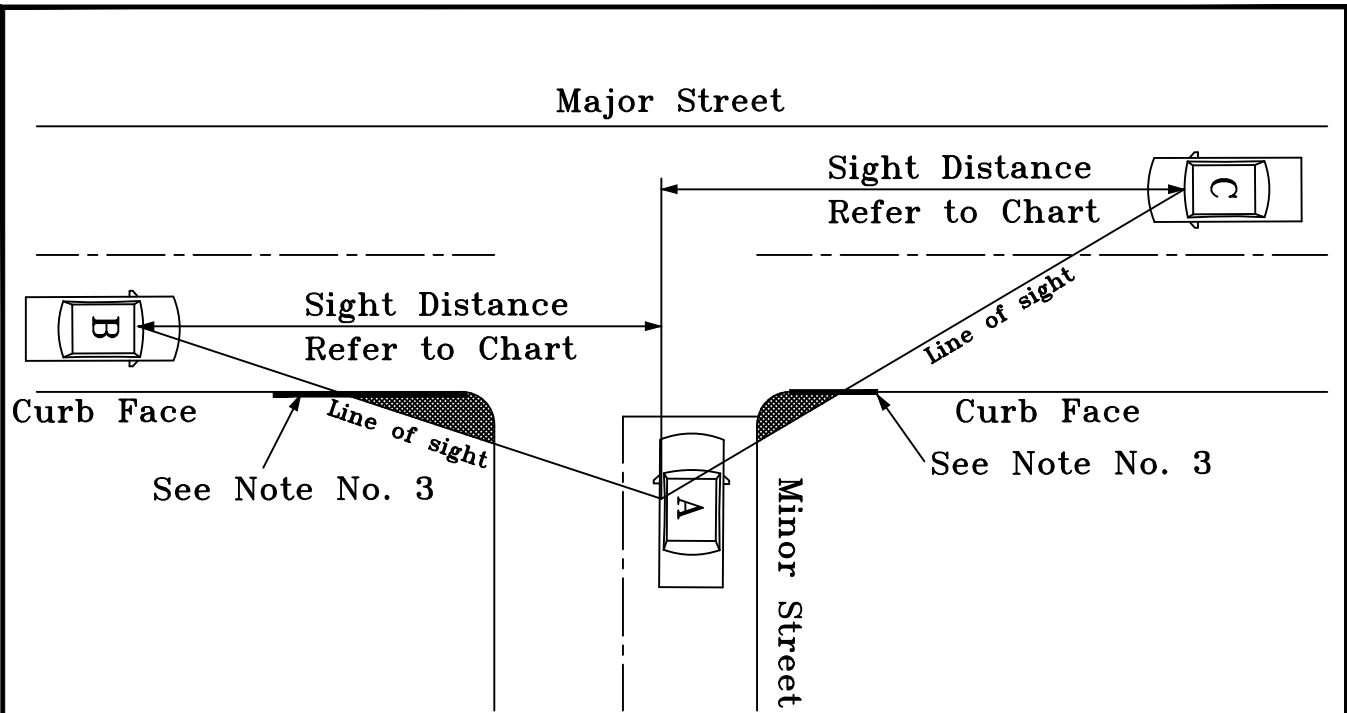

DESIGN SPEED (MPH)	25	30	35	40	45	50	55
SIGHT DISTANCE (FEET)	150	200	250	300	495	550	605

SPECIAL NOTE:

This design Standard shall be utilized at intersections and driveways where street speed limit is 35 miles per hour or more. All other streets shall conform with Fig. 3-3B.

NOTES:

- No mounds, fences, landscaping or monuments will be permitted within the shaded area more than 1 foot above the top of curb.
- Trees restriction within the shaded zone shall comply with the minimum standards:
 - Shall not exceed 6" in trunk girth.
 - Branches and canopy shall be maintained at 10 feet above the top of curb elevation.
- Parking shall be removed, as necessary, to provide adequate sight distance. Red curb shall be installed.
- Sight distance shall be measured with Vehicle A located 15 feet from the traveled way, as determined by the City Engineer. On streets with more than one lane in each direction, Vehicles A & B shall be in the lane with the greatest conflict.



CITY OF DIXON
ENGINEERING
DESIGN STANDARD



Approved: March 2022

SIGHT DISTANCE
TYPICAL INTERSECTION
AND DRIVEWAYS
(35 MPH AND MORE)

FIG.
3-3A

PUBLIC STREET

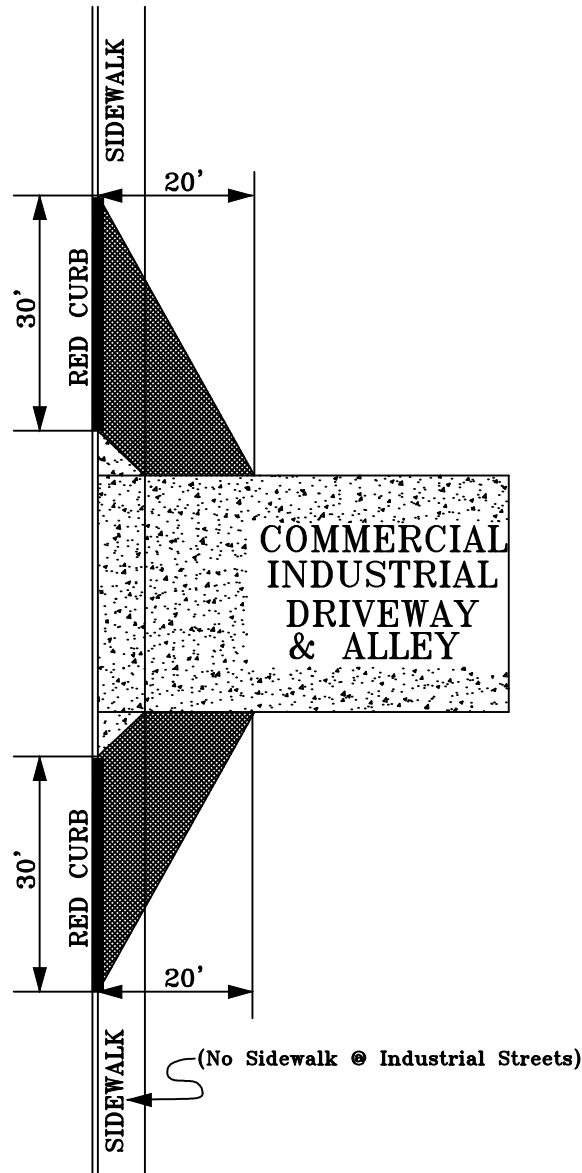

SPECIAL NOTE:

This design Standard shall be utilized at driveways where street speed limit are 30 miles per hour and less.

NOTES:

1. No buildings within the shaded area.
2. Fences, signs, walls, monuments and shrubbery may not exceed 3 feet in height, measured from top of curb, within the shaded area.
3. Trees restriction within the shaded zone shall comply with the minimum standards:
 - A. Shall not exceed 6" in trunk girth.
 - B. Branches and canopy shall be maintained at 10 feet above the top of curb elevation.
4. For speed limits of 30 MPH or less or else Fig. 3-3A shall apply.

FIG.
3-3B

**SIGHT DISTANCE
TYPICAL DRIVEWAYS**



Approved: March 2022

CITY OF DIXON
ENGINEERING
DESIGN STANDARD



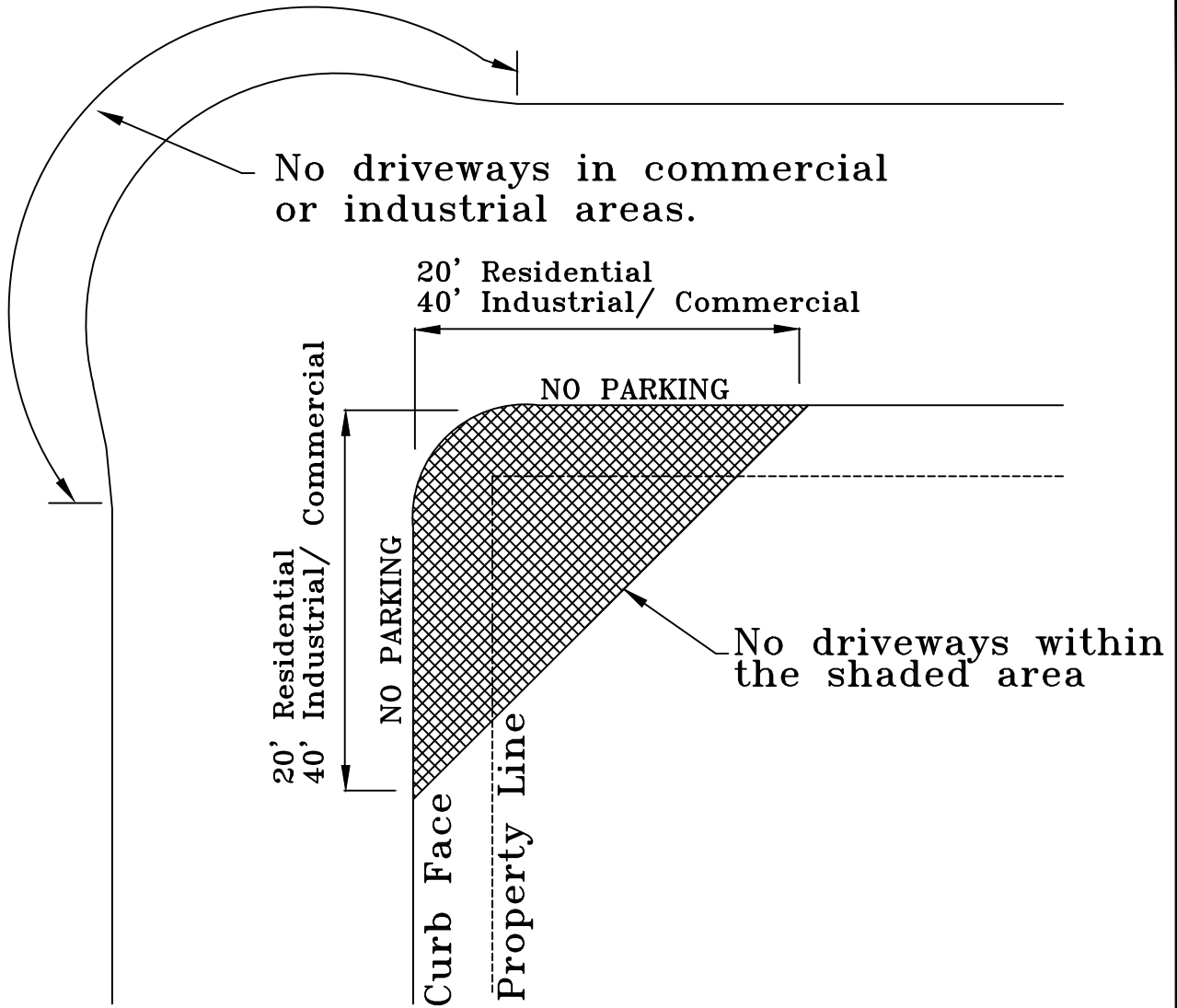

Notes:

1. No fences, trees or shrubs within the shaded areas.
2. No mounds over 1 foot above top of curb within the shaded area.
3. Trees restriction within the shaded zone shall comply with the minimum standards:
 - A. Shall not exceed 6" in trunk girth.
 - B. Branches and canopy shall be maintained at 10 feet above the top of curb elevation.



CITY OF DIXON
ENGINEERING
DESIGN STANDARD



Approved: March 2022

SIGHT DISTANCE
EXPANDED CORNER

FIG.
3-3C

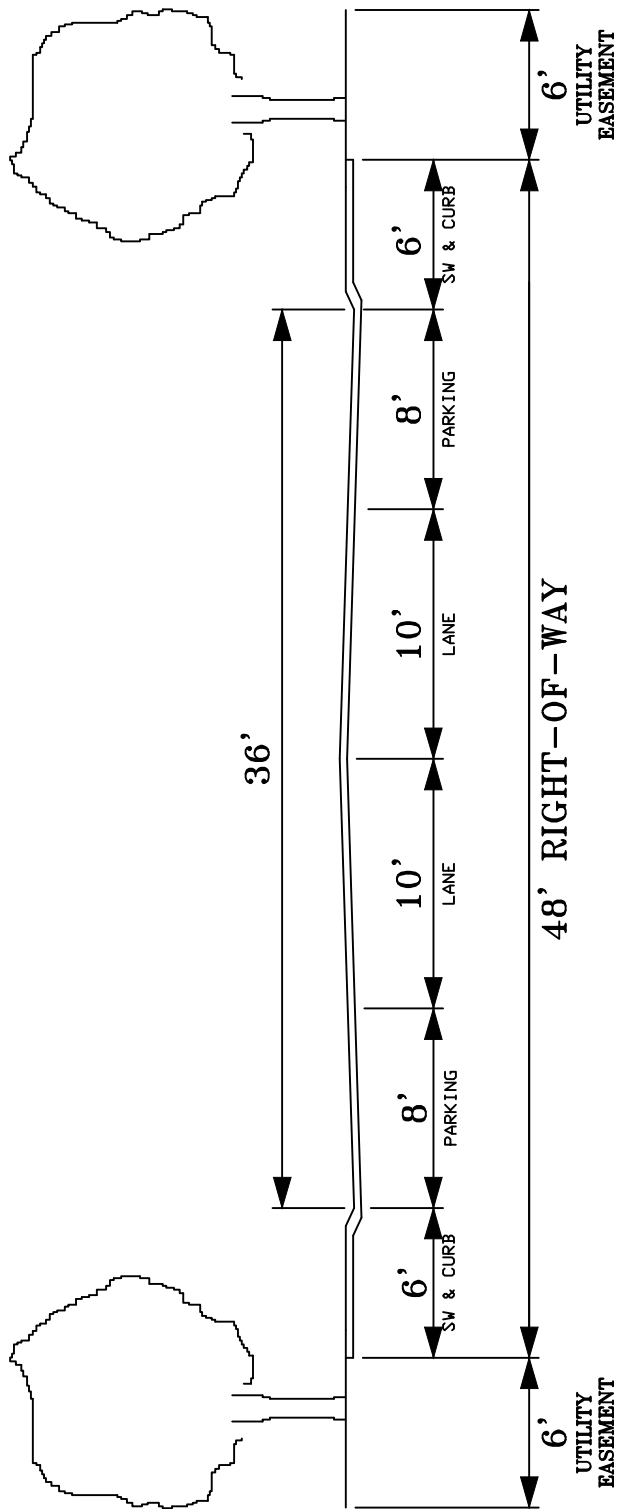

* INCLUDING LOCAL STREET WITH CUL-DE-SAC

LEGEND

SW = Sidewalk

FIG. 3-4A

LOCAL STREET STREET SECTION



Approved: March 2022

CITY OF DIXON
ENGINEERING
DESIGN STANDARD



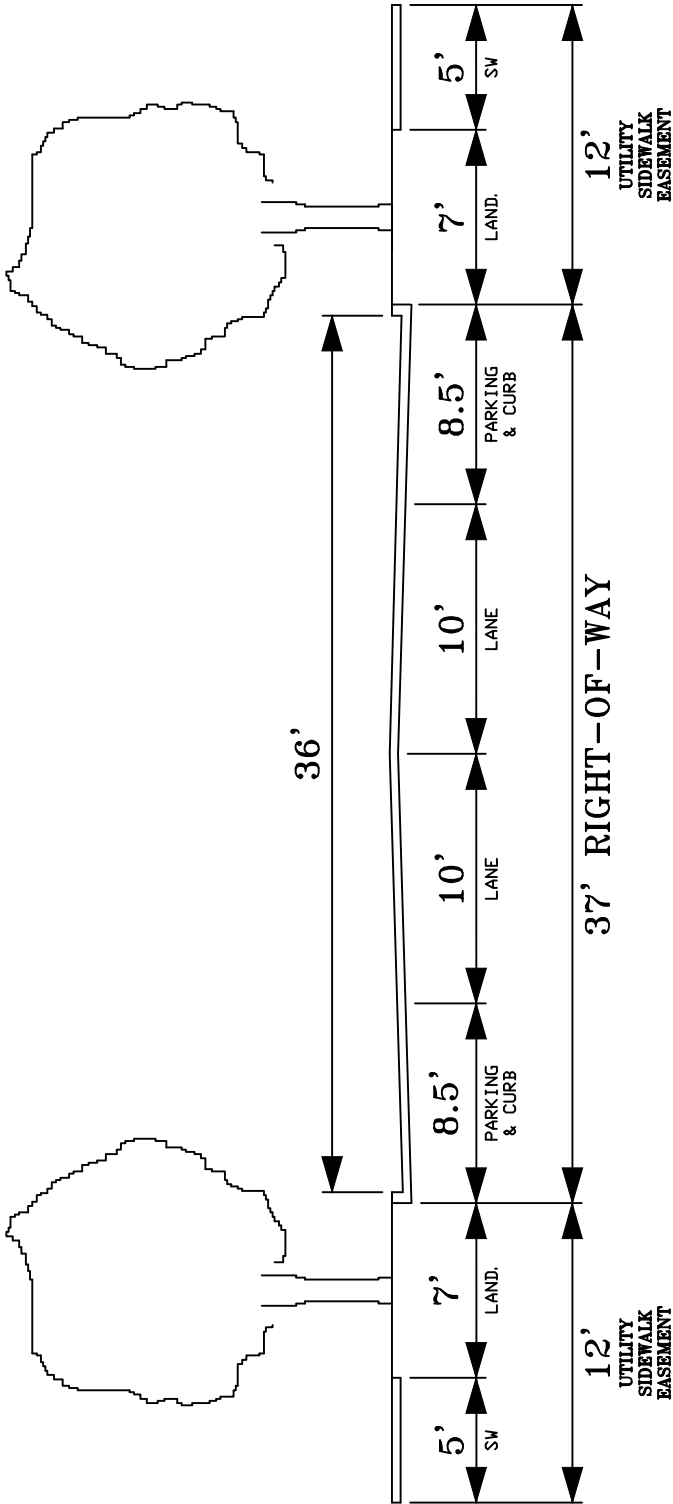

LOCAL STREET WITH SEPARATED SIDEWALKS

LEGEND
 LAND. = Landscape Area
 SW = Sidewalk



CITY OF DIXON
 ENGINEERING
 DESIGN STANDARD



Approved: March 2022

LOCAL STREET
 SEPARATED SIDEWALK
 STREET SECTION

FIG.
 3-4B

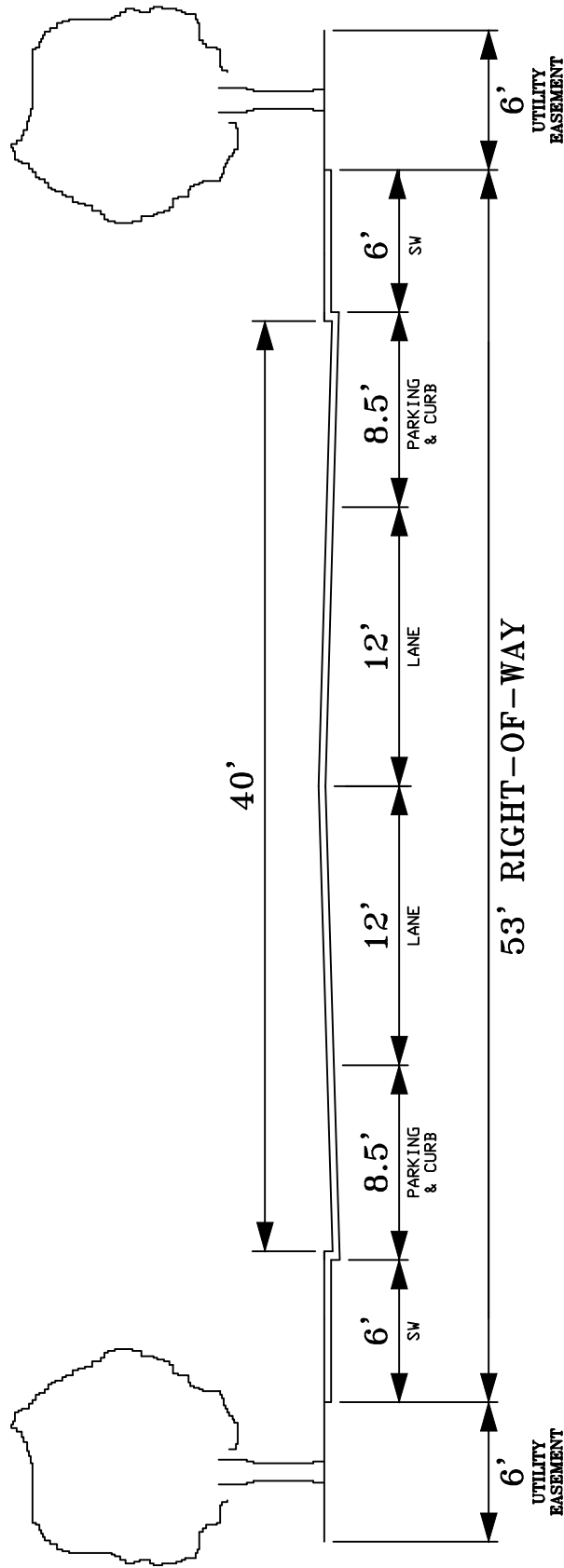

MINOR COLLECTOR

LEGEND
 SW = Sidewalk

FIG.
 3-4C

MINOR COLLECTOR
 STREET SECTION



Approved: March 2022

CITY OF DIXON
 ENGINEERING
 DESIGN STANDARD



RESIDENTIAL

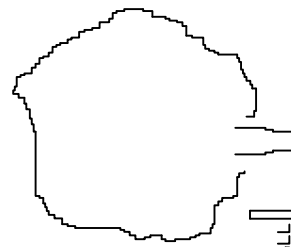

COMMERCIAL,
OFFICE, OR
INDUSTRIAL

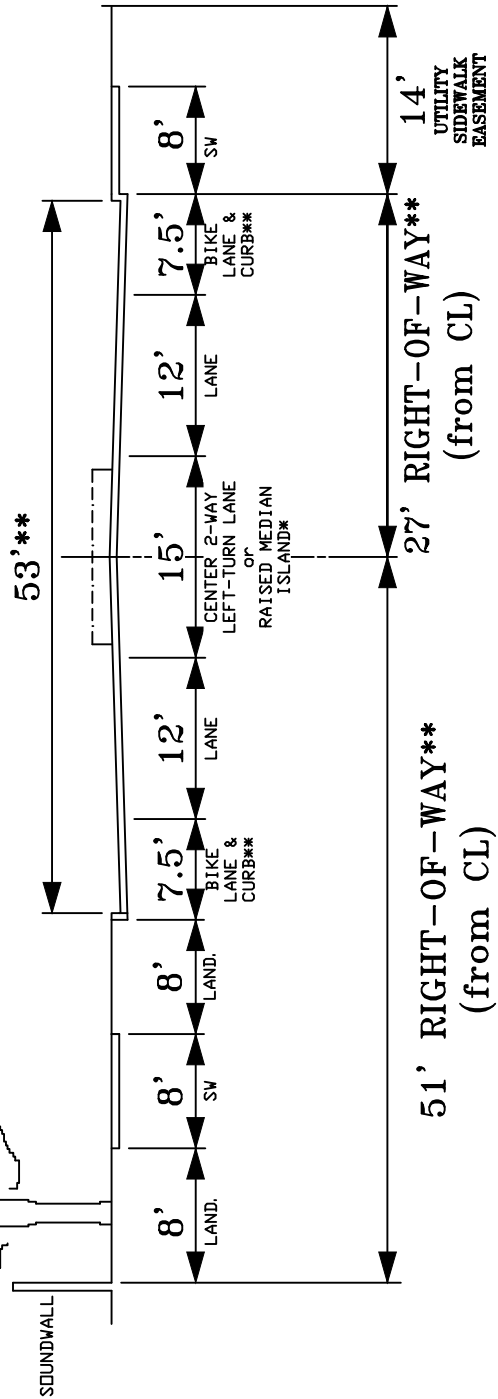

MAJOR COLLECTOR

LEGEND

- LAND. = Landscape Area
- SW = Sidewalk
- CL = Center Line

- * 13' WIDE MEDIAN ISLAND AND 13' LANES ADJACENT
- ** WHERE PARKING IS PROVIDED ON ONE SIDE OF THE STREET, USE FIGURE 3-4D FOR THE SIDE WITH NO PARKING AND FIGURE 3-4E FOR THE SIDE WITH PARKING.



CITY OF DIXON
ENGINEERING
DESIGN STANDARD



Approved: March 2022

MAJOR COLLECTOR
NO PARKING
STREET SECTION

FIG.
3-4D

RESIDENTIAL

COMMERCIAL,
OFFICE, OR
INDUSTRIAL

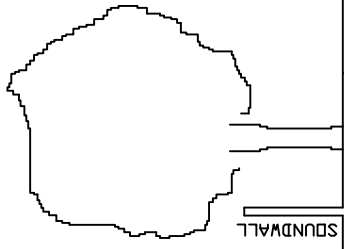

67' **

58' RIGHT-OF-WAY **
(from CL)

34' RIGHT-OF-WAY **
(from CL)

14'
UTILITY
SIDEWALK
EASEMENT

MAJOR COLLECTOR

LEGEND

- LAND. = Landscape Area
- SW = Sidewalk
- CL = Center Line

- * 13' WIDE MEDIAN ISLAND AND 13' LANES ADJACENT
- ** WHERE PARKING IS PROVIDED ON ONE SIDE OF THE STREET, USE FIGURE 3-4D FOR THE SIDE WITH NO PARKING AND FIGURE 3-4E FOR THE SIDE WITH PARKING.

FIG.
3-4E

MAJOR COLLECTOR
WITH PARKING
STREET SECTION

Approved: March 2022

CITY OF DIXON
ENGINEERING
DESIGN STANDARD



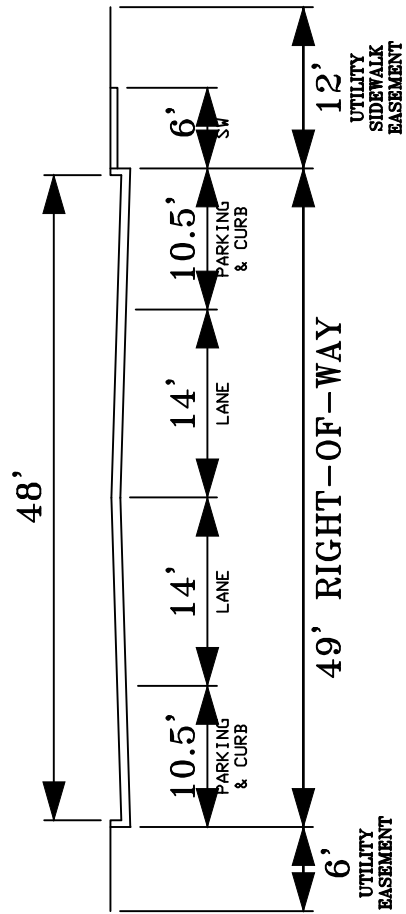

INDUSTRIAL COLLECTOR

LEGEND
 SW = Sidewalk



CITY OF DIXON
 ENGINEERING
 DESIGN STANDARD



Approved: March 2022

INDUSTRIAL COLLECTOR
 STREET SECTION

FIG.
 3-4F

COMMERCIAL,
OFFICE, OR
INDUSTRIAL

RESIDENTIAL

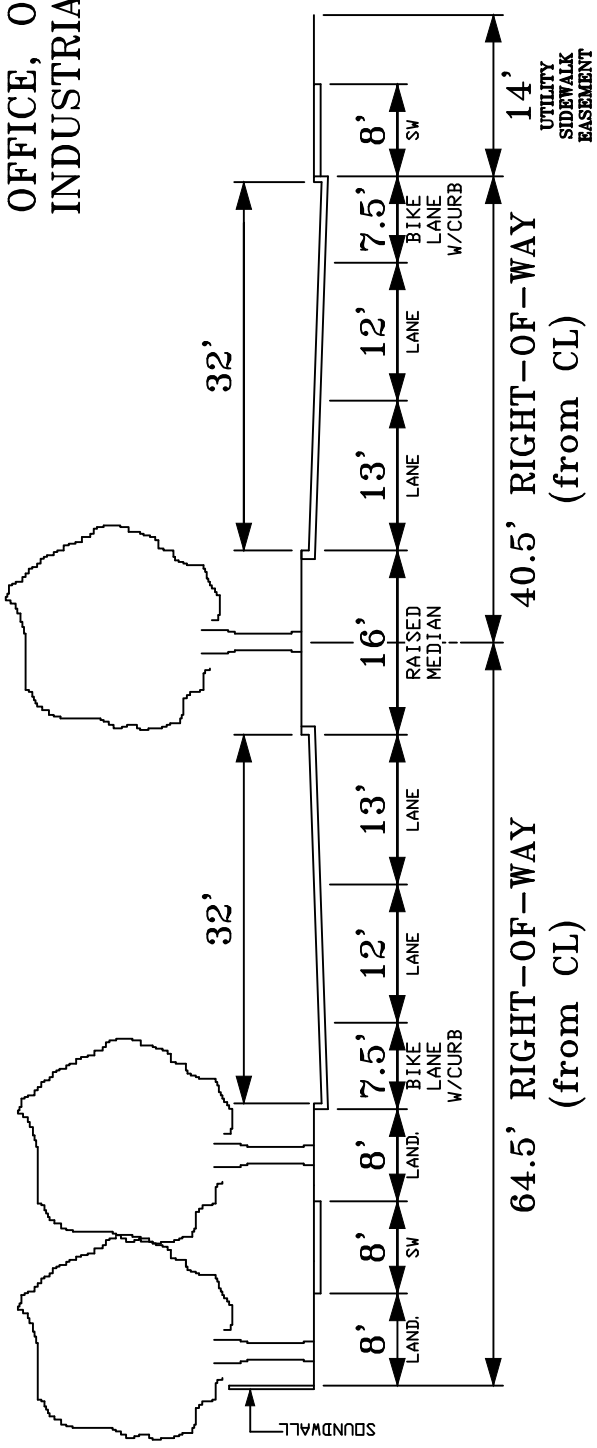

ARTERIAL

LEGEND

- LAND. = Landscape Area
- SW = Sidewalk
- CL = Center Line

FIG.
3-4G

ARTERIAL
STREET SECTION



Approved: March 2022

CITY OF DIXON
ENGINEERING
DESIGN STANDARD



RESIDENTIAL

COMMERCIAL,
OFFICE, OR
INDUSTRIAL

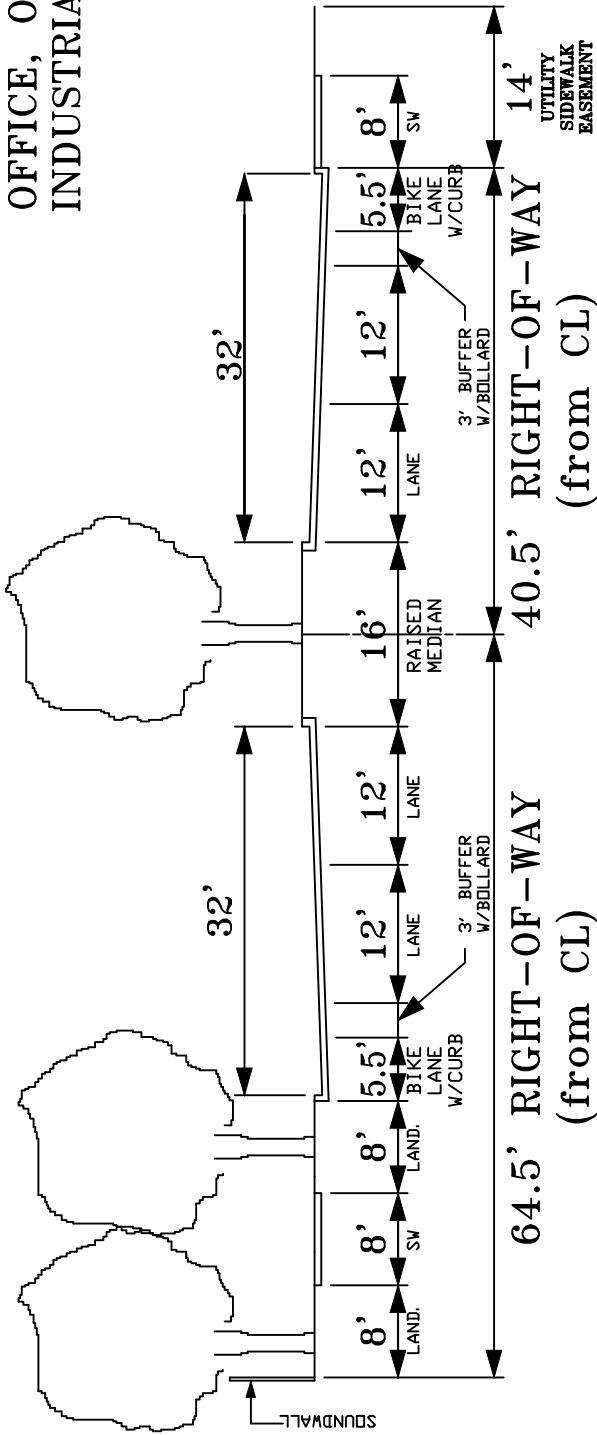

ARTERIAL WITH CLASS IV BIKEWAY

LEGEND

- LAND. = Landscape Area
- SW = Sidewalk
- CL = Center Line



CITY OF DIXON
ENGINEERING
DESIGN STANDARD



Approved: March 2022

ARTERIAL
WITH CLASS IV
BIKEWAY
STREET SECTION

FIG.
3-4H

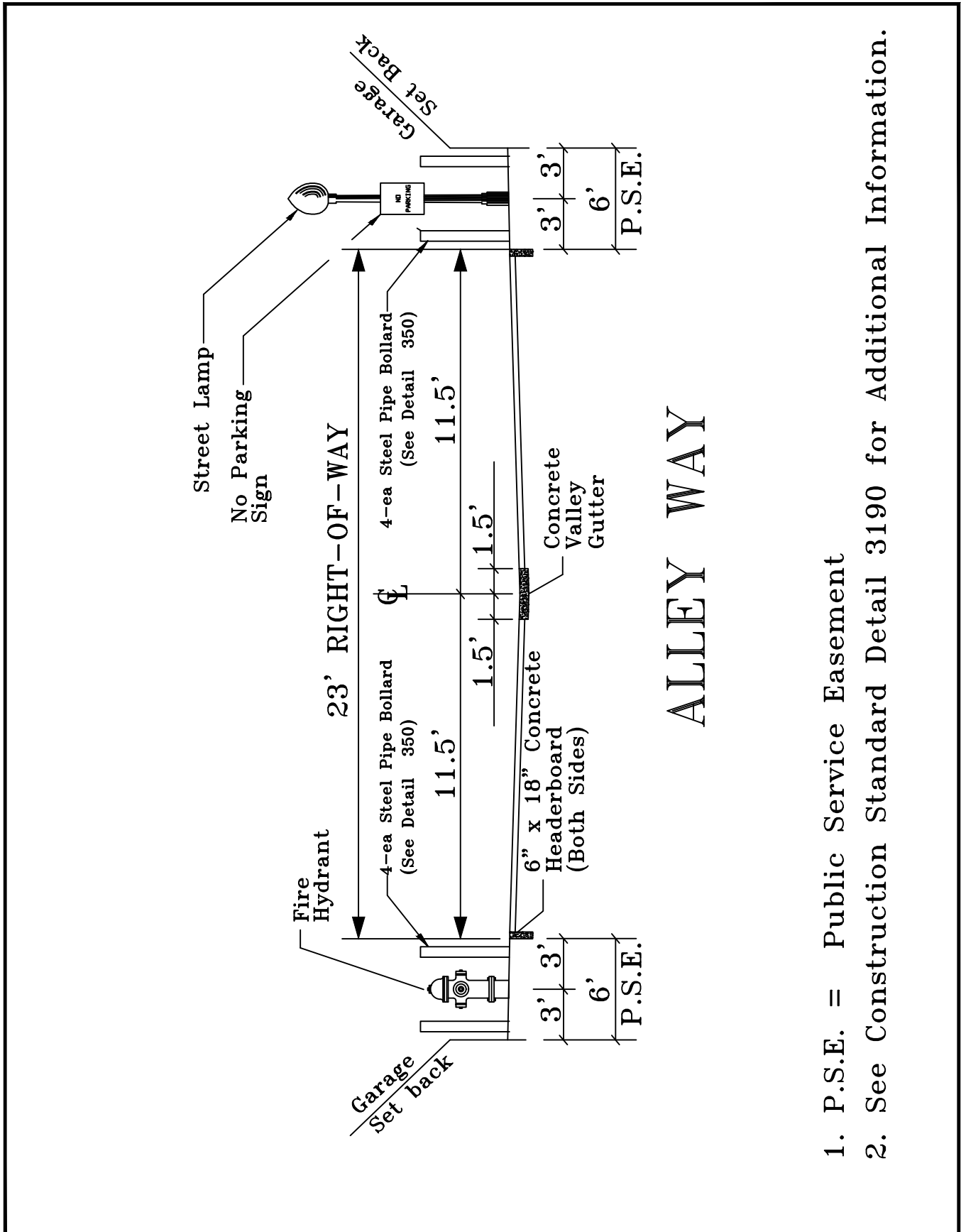

1. P.S.E. = Public Service Easement
2. See Construction Standard Detail 3190 for Additional Information.

ENGINEERING DESIGN STANDARDS

SECTION 4 – DRAINAGE DESIGN

DS4-01. GENERAL:

A. Submittals.

The Design Engineer shall submit a storm drain report (design information and calculations) for approval prior to the initial submittal of Improvement Plans. The design report shall include, but not be limited to, the following:

1. Topographic map showing existing & proposed ground elevations and total shed and sub-shed areas in acres.
2. Tributary area, land use and design flow at each structure.
3. Design flow in each pipe, channel, or pond.
4. Hydraulic grade line (HGL) at each structure and slope of the HGL between structures shall be shown on the storm drain profile.
5. Gutter flow line, pipe crown and invert elevations at each structure.
6. Pipe size, material, class, length, and slope.
7. Typical cross-sections of open channels.
8. Overland release points of drainage system and estimate of maximum water surface elevation of the 100-year storm.
9. Adjacent building pad elevations.

B. Acceptable Storm Discharges

The City Storm Drainage System is designed to convey clean stormwater runoff. All runoff containing any toxic substances or any human wastes shall not be discharged into the storm system, onto public streets or onto any lands tributary to the City maintained drainage system. All such wastes shall be appropriately pre-treated, as required, and discharged to the City Sewer System.

C. Design Storm Requirements (These design storm data include an 18 percent increase from historic data to account for climate change to 2050 to 2099).

1. Storm drains – 10-year storm. (See Figure 4-1)
2. Open channels – 100-year storm. (See Figure 4-1)
3. Detention Ponds – 100-year, 4-day storm. (See Figure 4-1)
4. Retention Ponds – 100-year, annual rainfall. (See Figure 4-2)
5. Overland Release – 100-year storm. The development grading shall be designed to achieve the building pad freeboard criteria even if the drain inlets and storm drain system are clogged.

D. Other Requirements

1. Infrastructure that will be owned, operated, and maintained by the City should be designed to minimize future operations and maintenance (O&M) labor and costs (versus minimizing initial construction and capital costs).
2. The stormwater system O&M costs shall be estimated, and an O&M funding mechanism must be established.

3. All engineering planning and design work shall use the North American Vertical Datum of 1988 (NAVD88).
4. The City Engineer may allow deviations from these standards. Requests for deviations should 1) be submitted in writing, 2) clearly state the deviation requested, 3) explain why the standard cannot be achieved and why the deviation is needed, 4) provide an approval or denial signature block for each requested deviation. The deviations are not authorized until they have been approved in writing by the City Engineer.
5. All storm drainage facilities shall comply with the current NPDES permit, trash capture requirements, low impact development requirements, hydro-modification requirements, and applicable state and federal requirements.

DS4-02. DESIGN RUNOFF:

- A. For areas up to 100 acres: Use Figures 4-3 through 4-6 at the end of this section. The Rational Method may be used, but it should reproduce the peak runoff rates from these figures. If the Rational Method is used for a storm drain that flows into a detention basin, the basin should be assumed to be half full (by volume) to establish the starting water surface elevation for the Rational Method.
- B. For areas larger than 100 acres and for any area where detention storage is proposed: Use a computer model with the model parameters adjusted to produce runoff rates consistent with runoff curves in Figure 4-3 through 4-6. The SacCalc model and XPSWMM using the Sacramento Method are two models that can be used and will directly reproduce the peak runoff rates in Figures 4-3 to 4-6 for developed land (see notes on the figures).
- C. Impervious Percentages for various land uses are presented in Figure 4-7.
- D. For areas that drain into existing storm drain facilities that were sized using previous standards, the City Engineer may approve use of other runoff rates.

DS4-03. HYDRAULIC GRADE LINE: The design of the storm drain system shall satisfy the following criteria regarding hydraulic grade line (HGL):

- A. 10-year HGL shall be at least 1.0 foot below gutter flow line.
- B. 100-year HGL shall be at least 1.0 foot below pad elevations.
- C. For drains that discharge into existing storm drains that were sized using other standards, the City Engineer may allow deviation these HGL standards.

DS4-04. INLETS, GUTTERS, AND STREETS:

- A. Drain Inlet spacing – maximum gutter flow length shall be 400 feet from summit to inlet.
- B. Longitudinal gutter slope – minimum longitudinal gutter slope shall be 0.35 percent and 0.5 percent through all curb returns and cul-de-sac bulbs.
- C. Street conveyance – streets shall be designed to store or transport the difference between storm drain capacity and the 100-year storm runoff. The Design Engineer shall provide written evidence that the project can safely withstand the effects of a 100-year storm event.

- D. The maximum area allowed to drain into any one drain inlet is 2 acres.
- E. Location- inlets are to be located at property lines whenever possible. At curb returns, inlets are to be located on the local street side of the curb return (street with lesser traffic).
- F. Intersection drainage – no crossflow valley gutters at intersections are permitted without prior written approval of City Engineer.
- G. Drain inlets shall conform to Construction Details 4510 through 4570, or an approved equal with written approval of City Engineer. Type A (grate drain inlet) over Type B (hooded drain inlet) shall be utilized at street curb & gutter locations unless Type B is approved by the City Engineer.
- H. Minimum drop from invert of inlet to invert of connection at storm drain shall be 0.25 feet.
- I. Vertical curb and gutter required at all inlets (see Construction Details 4550, 4560 & 4570).
- J. Trash racks may be required when, in the opinion of the City Engineer, they are necessary to prevent clogging of the storm line or to restrict access.

DS4-05. STORM DRAINS:

- A. HGL Design – Pipe drainage systems shall pass the peak runoff from the 10- year storm with the design HGL at least 1.0 feet below the gutter flow line.
- B. Materials – Allowable pipe material include reinforced concrete pipe (RCP). Other materials such as cast-in-place concrete pipe (CIPCP), non-reinforced concrete, corrugated steel, corrugated aluminum, ductile iron, and plastic (PVC, ABS, HDPE) may be used only with prior approval of the City Engineer. If metal pipe is used, it must be certified to have a service life of no less than 50 years, in accordance with Section 7-851.3 of Caltrans Highway Design Manual. If CIPCP is used, a detailed soils report addressing the placement of CIPCP shall be submitted and approved by the City prior to approval of any Improvement Plans. Pipe material shall be specified on plans (RCP, CIPCP, etc.).
- C. Manning’s formula shall be used to determine design parameters such as capacity, slopes, hydraulic grade lines and velocity. Computation shall be based on the following Manning’s “n” roughness coefficients:

Roughness Coefficients	
Material	Manning’s “n”
Reinforced Concrete	0.013
Corrugated Metal	0.024
Ductile Iron	0.013
Plastic (PVC, ABS, HDPE)	0.011
Open Channel- Fully Lined	0.018
Open Channel- Lined Bottom	0.030
Open Channel- Earthen	0.035
Open Channel- Natural	0.060

- D. Size – The minimum diameter for storm drain mains shall be 18 inches. The minimum diameter of a lateral from a street drainage inlet to a manhole shall be 12 inches.

- E. Minimum velocity – The minimum design velocity in pipes shall be 2 feet per second flowing full.
- F. Minimum cover – The minimum cover shall be 18 inches from subgrade unless otherwise approved by the City Engineer.
- G. Horizontal Alignment – The storm drains shall typically be located underneath gutter flow line. Storm drains shall have at least 5 feet of horizontal clearance with any parallel underground utility.
- H. A vertical alignment of not less than 12 inches shall be maintained between all storm drains and all crossing utilities, and a vertical clearance not less than 6 inches shall be maintained between all private storm services and all private crossing utilities.
- I. Easement – The minimum easement for any storm drain not within public rights-of-way shall be 15 feet. Additional easement width for storm drains larger than 36 inches in diameter and/or for depths of storm drain greater than 8 feet will be required, as determined by the City Engineer.
- J. Horizontal curves may be allowed with prior written authorization by the City Engineer provided the joint deflection is no more than 80 percent of the manufacturer’s recommendation.
- K. Inverted siphons are not permitted.
- L. Private Connections – The maximum area which will be allowed to drain across the sidewalk or driveway into the public street right-of-way shall not exceed 10,000 SF in residential areas and 5,000 SF in office, commercial or industrial areas. Any drainage exceeding these limitations shall be collected via an underground pipe system and connected to a defined drainage system, whether public or private. The minimum size of private service shall be 12 inches in diameter and shall connect to the system at an inlet or manhole. A clean-out box (2’ diameter) shall be installed at the right-of-way for all other connections. All private service connections shall be sized and designed to convey the peak 10-year flows as calculated in accordance with this standard.
- M. Small drains through the curb and under the sidewalk will be acceptable with approval by the City Engineer. The Design Engineer shall prepare and show details of this type of drain on the plans. The drain shall be capable of passing the 10-year storm flows without overtopping the sidewalk. Provisions shall be made to prevent leaves and debris from interrupting the function of the drain.

DS4-06. MANHOLES:

- A. Manholes – Manholes shall be located at the following points:
 - 1. Storm drains 42" in diameter and smaller – 400 feet maximum spacing
 - 2. Storm drains 48" in diameter and larger- 500 feet maximum spacing
 - 3. At changes in pipe size, direction and/or grade
 - 4. At intersections of all main lines
 - 5. Beginning and end of curved alignment

See Construction Details 4000 through 4050, and 4500.
- B. A drop of 0.10 feet through a manhole is required when the deflection angle between the inlet and outlet pipe(s) exceeds 45°. The deflection angle through a manhole shall not exceed 90

degrees. The invert of an incoming line shall not be higher than 12 inches above the crown of the largest pipe. In general, when the incoming line is smaller than the outgoing line, the crown of the incoming line shall match the crown of the outgoing line.

- C. Drain Inlet Substitution for Manhole – A standard City Drain Inlet with a manhole cover may be substituted for a manhole. Access for maintenance of pipe shall be provided.
- D. Manhole Access Roads – Roads designed for maintenance access shall be provided to all manholes not within a public right-of-way. The access road shall be a minimum width of 12 feet. The structural section shall be 8 inches of Class II aggregate base on geotextile fabric, and when required by the City Engineer, 3" of asphalt concrete.

DS4-07. OPEN CHANNELS: Open channels are not allowed except in special circumstances and requires prior review and written approval of the City Engineer.

If approved by the City Engineer, the minimum criteria for open channels includes the following provisions:

- A. Roads designed for maintenance access shall be provided to all channels. The access road shall be a minimum width of 12 feet with 4-foot shoulders on each side. As required by the Fire Marshall, maintenance roads shall be constructed with 60 feet by 20 feet wide turnouts, including shoulders, at 300 feet intervals. The structural section shall be 8 inches of Class II aggregate base on geotextile fabric, and when required by the City Engineer, 3" of asphalt concrete.
- B. The channel shall be designed to convey the 100-year storm. Minimum freeboard shall be 1 foot if the design water level is below the surrounding ground surface and shall be 3 feet if the design water level is above the surrounding ground surface.
- C. A small diameter pipe may be required by the City Engineer to be installed in conjunction with the linear pond/open channel to convey low flows through the channel.
- D. Erosion control shall typically include riprap and/or hydroseeding pending the City Engineer's approval in all impacted areas. Additional erosion control, subject to the review and approval of the City Engineer, may be required at bends, culverts, and inflow areas.
- E. Maximum design velocity shall be 3 feet per second unless additional erosion protection is included.
- F. Side slopes shall be no steeper than 4 horizontal to 1 vertical. Steeper slopes may be allowed if concrete lined, or with approval of the City Engineer.
- G. Fencing shall be installed unless otherwise approved by the City Engineer. Fencing to be typical 6 feet high screened-type, such as chain-link with slats.

DS4-08. DETENTION POND CRITERIA:

- A. Capacity – Detention storage facilities shall be designed to safely store the flow from the critical 100-year storm event using the analysis methods described in Section DS4-02. Minimum freeboard during the 100-year design storm shall be one foot if the design water level is below the surrounding ground surface. Minimum freeboard during the 100-year design storm shall be 3 feet if the design water level is above the surrounding ground surface. To

account for potential preceding storms, the basin should be assumed to be 25 percent full (by volume) at the start of the 100-year, 4-day design storm.

- B. Configuration – Maximum depth shall not exceed 10 feet and the pond bottom shall be at least 2 feet above historic groundwater levels based on groundwater investigations approved by the City Engineer. If supported by the groundwater investigation the City Engineer may allow basins to be deeper than 10 feet. The slope of all banks or levees subject to inundation shall be no steeper than 4 horizontal to 1 vertical. All slopes shall be protected by hydroseeding or the equivalent. In addition, slopes within public access areas such as parks and green belts shall be no steeper than slope of 6:1 unless otherwise approved by the City Engineer.
- C. Access – Roads designed for maintenance access shall be provided around the perimeter of all storage facilities. The top of the levee shall be 12 feet wide and 4 feet wide shoulders with an access road width of 12 feet. As required by the Fire Marshall, maintenance roads shall be constructed with 60 feet by 20 feet wide turnouts, including shoulders, at 300 feet intervals. The structural section shall be 8 inches of Class II aggregate base on geotextile fabric, and when required by the City Engineer, 3" of asphalt concrete. A 12 feet wide and 4 feet wide shoulders access road shall also be provided to the floor of the storage facility with a maximum slope of 10 percent.
- D. Perimeter Fencing – Fencing shall be installed 6 inches inside the property line of the storage facility with adequate access including vehicle and walk gates. Fencing shall be 6 feet in height, chain-link with slats or otherwise approved by the City Engineer.
- E. Multiple Use – Storm drainage detention basins may include additional uses such as parks/play areas/sports facilities, wetlands, wildlife areas or groundwater recharge. Additional requirements for such facilities may include irrigation systems, landscaping, bike or walking paths, flatter slopes, and plantings for wildlife enhancement. The City Engineer will specify what multiple uses shall be included in detention basins.
- F. Detention – Outlet facilities for detention storage shall be designed to discharge the maximum allowable flow based on project conditions. Discharge capacity shall be determined on a case-by-case basis and subject to review and approval of the City Engineer. Design Engineer shall provide an emergency spillway or overflow provisions for extreme conditions. Suitable backup systems and/or redundant pumping capability shall be provided subject to approval of the City Engineer.
- G. Retention – Shall be designed in accordance with Section DS4-9, “Retention Pond Design Criteria.”

DS4-9. RETENTION POND CRITERIA: Retention ponds may be used with prior written authorization by the City Engineer. If authorized, they will be sized using criteria provided below.

- A. Determine the pervious and impervious tributary areas. For the purpose of estimating runoff volumes, be sure to include the retention basin area as an impervious surface.
- B. Set up a spreadsheet analysis as shown in Figure 4-2 or obtain an electronic copy of the spreadsheet from the Public Works Department.
- C. Using the 100-year monthly design rainfall (provided in attachment Figure 4-2) calculate the monthly runoff from the impervious area (the design rainfall times the impervious area).

- D. Using the 100-year monthly effective rainfall (provided in Figure 4-2) calculate the monthly runoff from the pervious areas (the effective rainfall times the pervious area).
- E. Determine the total retention basin inflows by adding the pervious and impervious monthly runoff.
- F. Develop a relationship between the retention basin volume and the water surface area and water depth. In the sample (provided in Figure 4-2), the basin was assumed to be square to simplify development of these relationship. However, this assumption may not be applicable for a specific site.
- G. Assume the retention basin is empty on October 1. This assumption is based on the City of Dixon Engineering Standard DS4-08B, which requires the basin bottom to be at least 2 feet above historic groundwater levels. Since the maximum depth for basins is 10 feet, this assumption is likely to be correct, but should be verified for a specific site.
- H. Determine the potential unit evaporation rate from the retention basin. Reasonable evaporation rates for Dixon are provided in Figure 4-2.
- I. Determine the potential evaporation loss by multiplying the potential unit evaporation rate by the water surface area.
- J. Estimate the potential percolation loss from the pond to the groundwater. If rates higher than the rates shown in the sample spreadsheet are to be used, a geotechnical evaluation of the specific site is required to accurately quantify the long term (for life of the pond) percolation rate. The geotechnical evaluation shall be submitted to the City Engineer as part of the sizing/design of the retention basin.
- K. Determine the total basin loss by adding the potential evaporation loss to the potential percolation loss. The total loss cannot be more than the start-of-month volume of stored water.
- L. Determine the end-of-month volume of stored water by adding the total runoff and subtracting the total loss from the start-of-month volume of stored water.
- M. Define the next month's start-of-month volume of stored water as being equal to the previous month's end-of-moth volume of stored water.
- N. Perform the water balance throughout the year, ending with September.
- O. Adjust the retention basin size (area and depth) until the minimum allowed freeboard exists at the time of maximum storage. Minimum freeboard shall be one foot if the design water level is below the surrounding ground surface. Minimum freeboard shall be 3 feet if the design water level is above the surrounding ground surface. At the end of the water balance (September, see Figure 4-2) the retention pond must be no more than 25 percent full. At least 1 foot of freeboard exists at the time of maximum storage (design standard DS4-08A), and at the end of the water balance (September, see Fig. 4-2) the retention pond is no more than 25 percent full.
- P. Retention Ponds shall be designed to criteria in DS4-08, item no. B through D.
- Q. DS4-08 (B), (C), (D) & (E) also apply to retention ponds.

DS4-10. PUMP STATION CRITERIA:

- A. Design Process – The pump station design process shall be a cooperative process between the designers and the City Engineer and shall include at least an initial meeting with the City Engineer, submittal and written approval of a predesign report (representing a 30 percent design), and submittal and comments on 50 percent design and the 90 percent design, and submittal and approval of the final construction plans and specifications. The design shall be consistent with and integrated with the City’s SCADA system.
- B. Firm Capacity – The firm capacity (with the largest pump out of service) of pump stations must be approved in writing by the City Engineer. The firm capacity must be coordinated with the detention or retention basin sizing and configuration. The pump station firm capacity will need to comply with downstream storm drain and open channel capacity limitations.
- C. Total Capacity – The pump station must include a backup pump equal to the capacity of the largest firm capacity pump.
- D. Wet Well – The wet well shall be designed American National Standards Institute/Hydraulic Institute Standards. A means to isolate the wet well shall be provided.
- E. Site – The site shall be configured to provide truck access to all equipment without backing up and at least two parking spaces.
- F. Debris Removal – The pump station shall include a trash rack and automatic rake that discharge into a dumpster. This debris removal system must comply with the state’s Trash Amendment requirements.
- G. Standby Generator – The pump station shall include a standby generator capable of operating all the firm capacity pumps simultaneously and a fuel tank that will provide 24 hours of firm capacity pump operation. The generator shall be enclosed in a sound attenuation structure.
- H. Crane – The pump station shall include a built-in crane that can remove all pump motors, pumps, and associated valves and equipment.
- I. Operations Building – The pump station shall include an operations building that contains the pump controls and electrical equipment, an equipment/parts storage room, an office, and a restroom.
- J. Fencing and Security – The pump station shall be enclosed in a block wall fence with razor topper. The fence shall include two 20-foot automatic gates that do not block traffic when open. The primary gate should have a Knox Box (see www.knox.com) for emergency access. The site shall surveillance cameras connected to and integrated with the City’s security system.
- K. Final Grade – The pump station final grade shall be at least 2 feet above the nearby 100-year water surface elevation.

DS4-11. ADDITIONAL DESIGN CRITERIA:

- A. Subdrainage facilities shall be provided when required by the City Engineer.
- B. Headwalls, wingwalls, culverts and outfalls shall be individually designed by the Design Engineer in accordance with the California State Standard Plans and Specifications unless otherwise approved by the City Engineer. Erosion protection shall be included as part of the design.

- C. Connections to existing systems shall be at locations approved by the City Engineer. The Design Engineer shall verify the downstream capacity of the existing system. Tapping into an existing system shall be detailed on the Improvement Plans.
- D. When off-site drainage enters the project area, the design of the drainage improvements shall include capacity to convey the off-site drainage at a rate consistent with ultimate buildout of the property, as approved by the City Engineer.
- E. Storm drain stubs shall be provided for future development on adjacent properties. Water-tight plugs shall be used.

This Page Intentionally
Left Blank



CITY OF DIXON
ENGINEERING
DESIGN STANDARD



Approved: March 2022

DESIGN STORM
RAINFALL DATA

FIG.
4-1

Figure 4-1. 10-Year and 100-Year Design Storm Rainfall Depths

	Time Duration												
	5 Min	10 Min	15 Min	30 Min	1 Hour	2 Hour	3 Hour	6 Hour	12 Hour	1 Day	2 Day	3 Day	4 Day
10-Year Rainfall Depth (inches)	0.34	0.46	0.55	0.74	1.00	1.36	1.60	2.16	2.90	3.92	5.25	5.72	6.38
100-Year Rainfall Depth (inches)	0.48	0.66	0.79	1.05	1.42	1.91	2.27	3.06	4.12	5.55	7.72	8.50	9.39

Note:

These design storm data include an 18 percent increase from historic data to account for climate change to 2050 to 2099. The increase is based on the 100-year return period, 1-day duration Representative Concentration Pathways (RCP) 4.5 for the Sacramento Area from Appendix B of Projected Changes in California's Precipitation Intensity-Duration-Frequency Curves, prepared for California's Fourth Climate Change Assessment, August 2018.

Rainfall-Runoff Analysis			Retention Basin Water Balance Analysis			
Impervious Average:	64.2	Retention Pond Area (acres):	28.4	25% of Maximum Volume (ac-ft):		58.7
Pervious Average:	35.8	Retention Pond Depth (ft)	10.0			
Total Average	100.0	Retention Pond Side Slope (H:V)	4			

Table 2. Rainfall-Runoff and Retention Basin Water Balance Analysis

Date	Design Rainfall (in)	Impervious Area Runoff (ac-ft)	Effective Rainfall (in)	Pervious Runoff (ac-in)	Total Runoff (ac-ft)	Start-of-Month Volume of Stored Water (ac-ft)	Water Surface Area (ac)	Water Depth (ft)	Potential Unit Evaporation Rate (in)	Potential Evaporation Loss (ac-ft)	Potential Unit Percolation Loss (in)	Potential Percolation Loss (ac-ft)	Total Loss (ac-ft)	End-of-Month Volume of Stored Water (ac-ft)
October	0.33	1.77	0.00	0.00	1.77	0.00	0.00	0.01	4.03	0.00	9.80	0.00	0.00	1.77
November	4.21	22.54	1.83	5.46	27.99	1.77	24.50	0.10	2.10	4.29	9.30	18.99	1.77	27.99
December	2.86	15.28	0.90	2.68	17.95	27.99	24.88	1.10	1.55	3.21	9.60	19.90	23.12	22.83
January	12.86	68.81	6.52	19.75	88.56	22.83	24.80	0.90	1.55	3.20	5.60	11.58	14.78	96.61
February	8.61	46.08	7.79	23.23	69.32	96.61	25.92	3.80	2.24	4.84	1.40	3.02	7.86	158.07
March	9.62	51.45	5.58	16.65	68.10	158.07	26.87	6.20	3.72	8.33	1.60	3.58	11.91	214.26
April	1.43	7.64	0.07	0.21	7.85	214.26	27.67	8.20	5.10	11.76	2.40	5.53	17.29	204.81
May	0.67	3.60	0.00	0.00	3.60	204.81	27.55	7.90	6.82	15.66	3.70	8.49	24.15	184.26
June	0.71	3.79	0.00	0.00	3.79	184.26	27.23	7.10	7.80	17.70	5.10	11.57	29.27	158.78
July	0.35	1.89	0.00	0.00	1.89	158.78	26.87	6.20	8.68	19.44	6.80	15.23	34.66	126.01
August	0.00	0.00	0.00	0.00	0.00	126.01	26.39	5.00	7.75	17.05	8.40	18.48	35.52	90.49
September	0.00	0.00	0.00	0.00	0.00	90.49	25.85	3.60	5.70	12.28	9.30	20.03	32.31	58.18
Total	41.65	222.85	22.79	67.98	290.83				57.04	117.75	73.00	136.40	232.64	
Maximum	12.86	68.81	7.79	23.23	88.56	214.26	27.67	8.20	8.68	19.44	9.80	20.03	35.52	214.26

Note:
 These design storm rainfall data include an 18 percent increase from historic data to account for climate change to 2050 to 2099. The increase is based on the 100-year return period, 1-day duration Representative Concentration Pathways (RCP) 4.5 for the Sacramento Area from Appendix B of Projected Changes in California's Precipitation Intensity-Duration-Frequency Curves, prepared for California's Fourth Climate Change Assessment, August 2018.
 These percolation rates are from the planning of the Dixon wastewater treatment plant percolation/evaporation basins. Different percolation rates may be appropriate for other sites. Site-specific percolation testing shall be performed to document use of other rates. The study shall be stamped and signed by a civil or geotechnical engineer.

FIG. 4-2

RETENTION BASIN WATER BALANCE

Approved: March 2022

CITY OF DIXON ENGINEERING DESIGN STANDARD



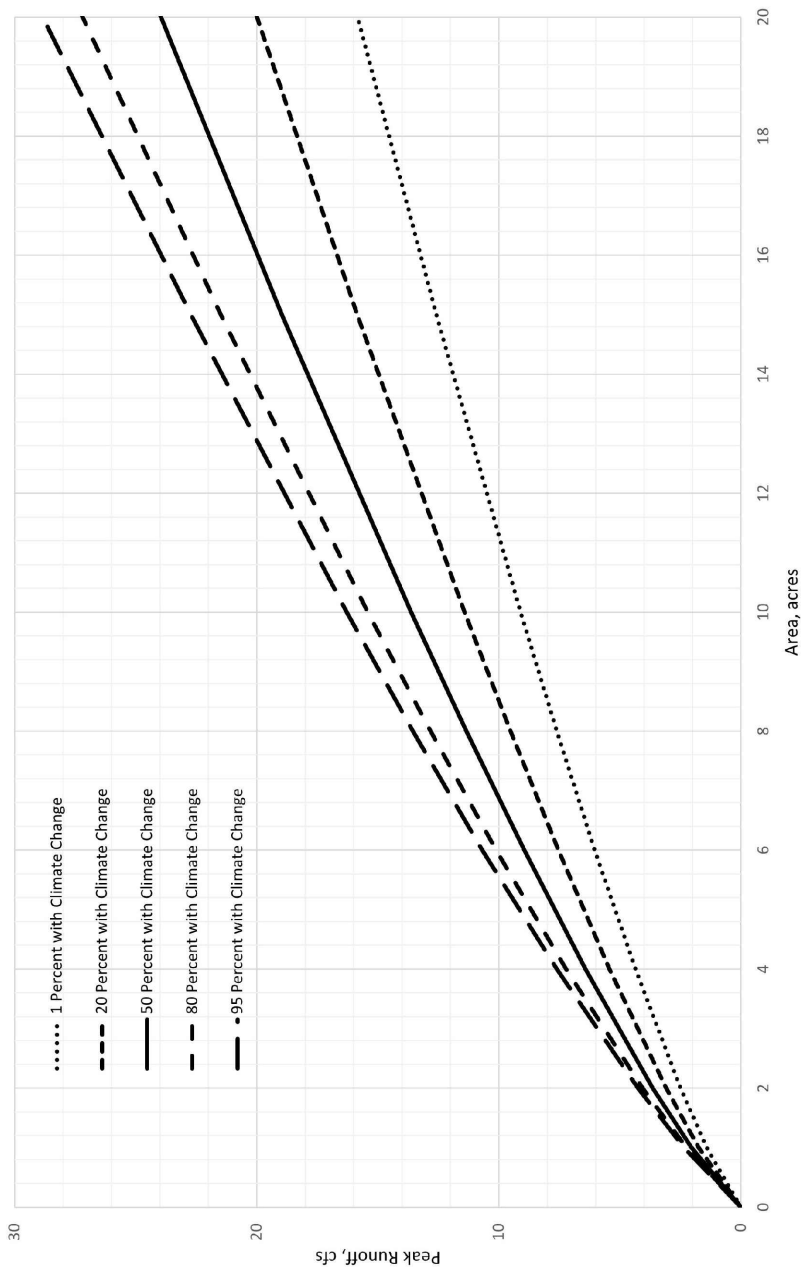

Notes:
 These runoff curves for developed land were generated with the Sacramento Method in XPSWMM, as follows:
 - Hydrologic soil group (HSG) D was used (for the high clay content and for compaction during construction activities).
 - The watershed is fully developed (for the channelization data).
 - An average ground slope of 0.001 was used.
 - The lag time parameters were calculated as length of watershed, $L = 737.9 * A^{0.5}$ where A = area (in acres), and $L_c = 0.5 * L$.



CITY OF DIXON
 ENGINEERING
 DESIGN STANDARD



Approved: March 2022

10-YEAR PEAK FLOW
 0 - 80 ACRES

FIG.
 4-3

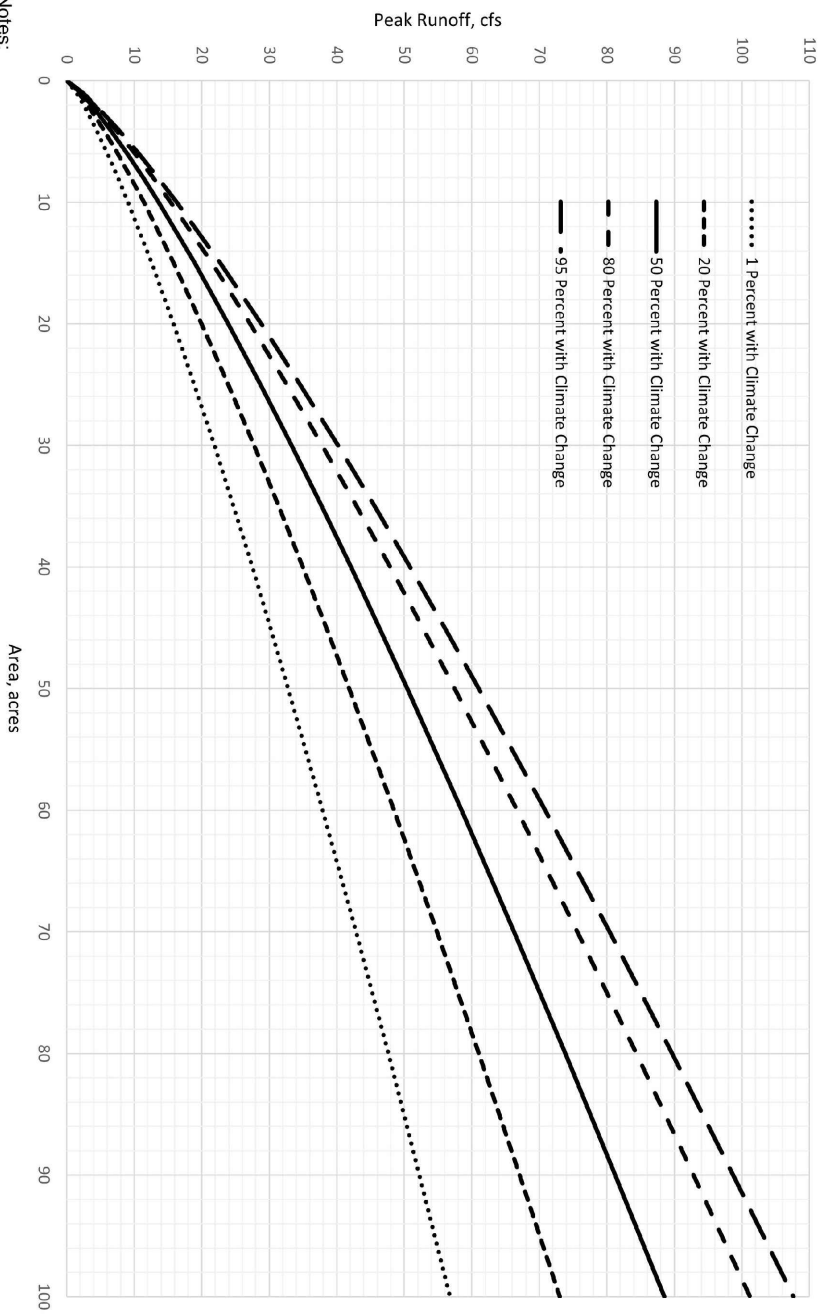

Notes:
 - These runoff curves for developed land were generated with the Sacramento Method in XPSWMM, as follows:
 - Hydrologic soil group (HSG) D was used (for the high clay content and for compaction during construction activities).
 - The watershed is fully developed (for the channelization data).
 - An average ground slope of 0.001 was used.
 - The lag time parameters were calculated as length of watershed, $L = 737.9 \cdot A^{0.5}$ where A = area (in acres), and $L_c = 0.5 \cdot L$.

FIG. 4-4

10-YEAR PEAK FLOW
 80 - 640 ACRES



Approved: March 2022

CITY OF DIXON
 ENGINEERING
 DESIGN STANDARD



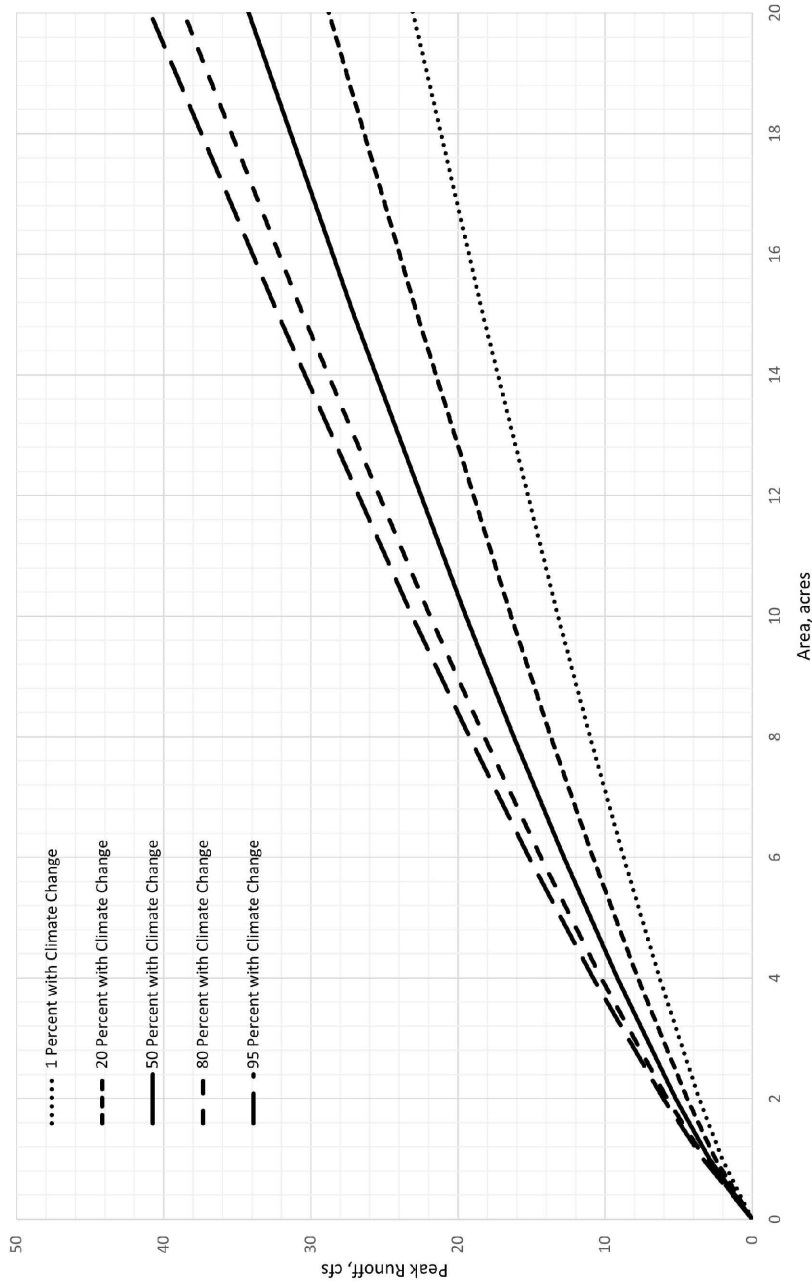

Notes:
 These runoff curves for developed land were generated with the Sacramento Method in XPSWMM, as follows:
 - Hydrologic soil group (HSG) D was used (for the high clay content and for compaction during construction activities).
 - The watershed is fully developed (for the channelization data).
 - An average ground slope of 0.001 was used.
 - The lag time parameters were calculated as length of watershed, $L = 737.9 * A^{0.5}$ where A = area (in acres), and $L_t = 0.5 * L$.

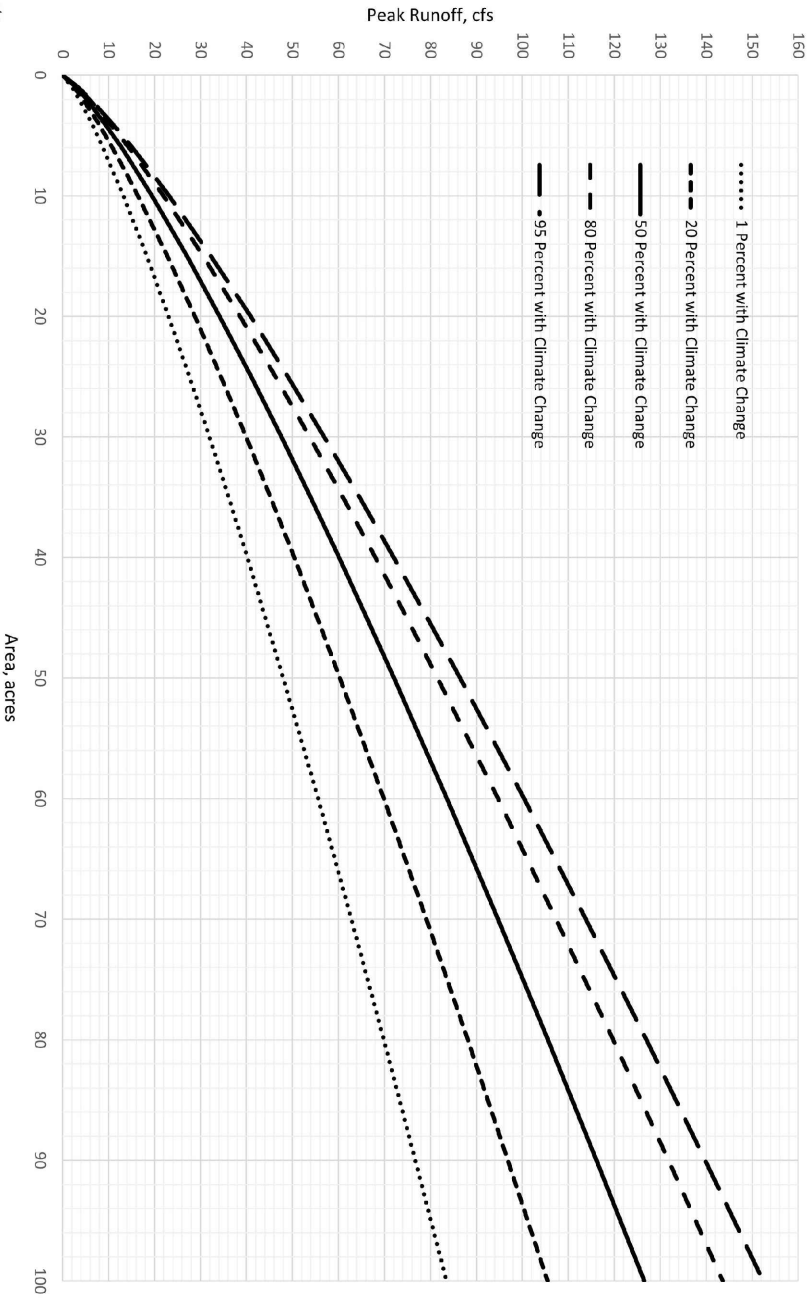

Notes:
 - These runoff curves for developed land were generated with the Sacramento Method in XPSWMM, as follows:
 - Hydrologic soil group (HSG) D was used (for the high clay content and for compaction during construction activities).
 - The watershed is fully developed (for the channelization data).
 - An average ground slope of 0.001 was used.
 - The lag time parameters were calculated as length of watershed, $L = 737.9 * A^{0.5}$ where A = area (in acres), and $L_c = 0.5 * L$.

FIG. 4-6

100-YEAR PEAK FLOW
 80 - 640 ACRES



Approved: March 2022

CITY OF DIXON
 ENGINEERING
 DESIGN STANDARD



Land Use	Percent Impervious
Highways, Parking Lots	95
Commercial, Office	90
Industrial	85
Apartments, High Density Residential	80
Mobile Home Park	75
Condominiums, Medium Density Residential	70
Residential (8-10 du/acre)	60-70
Residential (6-8 du/acre), Low Density Residential, Schools	50-60
Residential (4-6 du/acre)	40-50
Residential (3-4 du/acre)	30-40
Residential (2-3 du/acre)	25-30
Residential (1-2 du/acre)	20-25
Residential (0.5-1 du/acre)	15-20
Residential (0.2-0.5 du/acre)	10-15
Residential (<0.2 du/acre)	5-10
Open Space, Agricultural	2 - 5



CITY OF DIXON
ENGINEERING
DESIGN STANDARD



Approved: March 2022

LAND USES
AND
IMPERVIOUS PERCENTAGES

FIG.
4-7

This Page Intentionally
Left Blank

ENGINEERING DESIGN STANDARDS

SECTION 5 – WATER SUPPLY SYSTEM DESIGN

DS5-01. GENERAL:

Design of the domestic water system in the service area of the City of Dixon shall, unless otherwise noted, conform to the standards and references set forth below, and standard acceptable engineering practices. Water improvements shall be designed to serve the ultimate level of development as defined in the General Plan and the Water System Master Plan.

All improvements shall conform to the requirements with, but not limited to, the California Safe Drinking Water Act and Related Laws, the State Water Resources Control Board Department of Drinking Water, the California Plumbing Code, the National Board of Fire Underwriters, the California Fire Code, the California Building Code, and these Design Standards.

1.1 Abbreviations and Definitions

ARV: Air Release Valve

BFBs: Backflow Prevention Assemblies

Contractor: Any person or persons, firm, partnership, subdivider, company, or corporation supplying the materials or doing the work of installing water facilities

City Engineer: As used herein means the City of Dixon City Engineer

City Standards: The City of Dixon Engineering Standards and Specifications, latest revision

DI: Ductile iron

Engineer: The Project Engineer or his authorized representative

fps: feet per second

gpm: gallons per minute

Hydrant branch: The pipeline connecting a fire hydrant to a water main

Inspector: All persons employed by the City of Dixon responsible for inspection of City of Dixon improvements

Multi-family residence: Dwelling structures with two or more units

NEQ: North East Quadrant

psi: pounds per square inch

PVC: Poly Vinyl-Chloride

RP: Reduced Pressure Backflow Preventer

RPDA: Reduced Pressure Detector Assembly

Service Connection: The pipe extending from the main to the meter, including all of the pipe, fittings, valves and appurtenances, except the meter, necessary to make the installation

SID: Solano Irrigation District

USA: Underground Service Alert

Water Master Plan: The latest revision of the City of Dixon Water System Master Plan

1.2 References

- A. City of Dixon Engineering Standards and Specifications
- B. City of Dixon Construction Details
- C. City of Dixon Water Master Plan
- D. The City of Dixon Municipal Code for Water, being Chapter 14.02, Water, of the Dixon Municipal Code.
- E. American Water Works Association (AWWA) Standards.
- F. California Code of Regulations, Title 22, Division 4, Chapter 16, California Waterworks Standards.
- G. State Water Resources Control Board Division of Drinking Water (DDW).
- H. The Uniform Plumbing Code.
- I. Occupational Safety and Health Administration (OSHA)
- J. The California Building Code.
- K. Solano County Resource Management Department Well Standards
- L. State of California, Water Code Section 13750 thru 13755
- M. State of California, Department of Water Resources (DWR) Bulletin 74-81: Water Well Standards, State of California, December 1981 and Bulletin 74-90: California Well Standards, June 1991
- N. American Standard Testing Materials (ASTM)
- O. NSF/ANSI 60 Drinking Water Treatment Chemicals
- P. NSF/ANSI 61 Drinking Water System Components
- Q. California Air Resources Board and Air Quality Management District Standards
- R. American National Standard Institute/Hydraulic Institute (ANSI/HI)
- S. American Bearing Manufacturers Association (ABMA)
- T. International Organization of Standardization (ISO)

1.3 Improvement Plan Requirements

Improvement Plans are to include plans, profiles and details. A signature block, as shown in Figure 2-2 shall be provided for the City Engineer to approve the plans. A note shall be made on the plans to direct the Contractor to contact U.S.A. prior to any excavation, giving 48 hours' notice, as required by U.S.A., and include the U.S.A. phone number. The plans must show existing and proposed rights-of-way. Show existing and proposed main sizes and types, valves, air valves, hydrants, blow offs and other related facilities in both plan and profile views, except valves do not have to be shown in the profiles. Services shall be shown in the plan views, but need not be shown in the profiles. Show top of pipe elevation at all grade changes. Show and note points of connection to existing mains. Show clearance to all crossing utilities. Provide details where conflicts may occur to show how they are avoided.

1.4 Modifications

These Design Standards may be modified on a case-by-case basis by the City Engineer.

DS5-02. DISTRIBUTION FACILITIES:

2.1 Main Lines

2.1.1 Sizing

- A. Typical minimum size of main pipelines shall be 8 inches. A 6 inch pipeline may be used on dead-end lines having no fire hydrants, if it can supply the necessary flowrate and pressure.
- B. In all cases, water mains shall be large enough to meet the fire flow requirements established by the Insurance Services Office, the City of Dixon Fire Department, and those listed below.

2.12 Pipe Type

Allowable materials for public water distribution shall be DI or PVC.

2.1.3 Pressure and Flow Requirements

- A. Mains shall be sized to maintain 50 psi to 80 psi throughout the system under normal conditions. (Note that the system is set to operate between 55 psi and 65 psi.) Pipes shall be rated for a minimum 150 psi service unless a higher pressure rating is necessary.
- B. Peak hour pressures may drop to 45 psi.
- C. Fire flow demand must be provided simultaneously with the maximum daily demand on the system. The minimum fire flow rates shall be provided at a minimum of 20 psi for a minimum 3 hour period. The City of Dixon Water Master Plan, latest revision, presents the latest Fire Flow requirements.

<u>Zoning</u>	<u>Flowrate</u>
Single Family	1,500 gpm
Multi-Family	2,500 gpm
Commercial	3,500 gpm typical, 4,000 gpm North East Quadrant (NEQ)
Industrial	3,500 gpm typical, 4,000 gpm NEQ and future industrial areas east of the railroad tracks

- D. Pipeline design velocities shall be limited to 6 fps. A maximum water velocity of twelve (12) fps will be utilized when designing for fire flows and/or other emergency conditions.

2.1.4 Location and Clearance Requirements

- A. Mains shall be located within public rights-of-way or easements for public utilities. Easements shall conform to section DS5-05.4. Minimum width of 30 feet for 8 inch and smaller pipes and 40 feet for 12 inch and larger pipes.
- B. Mains within street rights-of-way shall generally be located 6 feet south or east of street centerlines.
- C. Main lines shall be laid straight, with direction changes made with fittings. Gradual curves of not less than manufacturer-recommended minimum radii may be used in curved streets and where approved by the City Engineer.
- D. Minimum cover over main pipelines shall be as follows:
Within paved areas: 30 inches from top of pipe to bottom of subgrade.
Outside of paved areas: 36 inches from top of pipe to finish grade.
Refer to Standard Detail Sheet 5000.
- E. Mains shall be looped in a gridiron pattern to eliminate dead-end pipes.

EXCEPTIONS:

- 1. Mains in cul-de-sacs may be dead-ended if any hydrant located at the start of the cul-de-sac is connected to a loop in the system, not the dead-end branch in the cul-de-sac.
 - 2. Mains may be dead-ended if they are to be extended in the near future and the planned extension will eliminate the dead-end conditions.
- F. Maximum spacing between parallel supply mains (12 inch pipes) shall be one-half mile (2,640 feet).
 - G. Mains adjacent to sanitary sewers and other non-potable pipelines shall be located in accordance with the California Waterworks Standards Title 22 CCR §64572 Refer to Standard Detail Sheets 5010, and 5210.
 - H. Water mains in streets planned to be extended in the future shall be extended past the edge of pavement and through public service easements.
 - I. Water services and sewer laterals may be run in the same trench, but ONLY if the requirements of the Uniform Plumbing Code, Section 1108, are met. Designers are responsible to make themselves aware of the exact wording of that section. The basic requirements are:
 - 1. The bottom of the water pipe shall at all points be at least 12 inches above the top of the sewer lateral pipe.
 - 2. The water service pipe shall be placed on a solid shelf excavated at one side of the common trench, with a minimum clear horizontal distance between the sewer and water pipes of 24 inches.

2.2 Main Pipeline Appurtenances

2.2.1 Valves

- A. Valves shall be located so that any section of main line may be isolated, and so that no more than two fire hydrants are removed from service.
- B. Valves shall be installed in main lines at the boundary of development if the main pipeline is to be extended in the future.
- C. Maximum spacing of valves shall be 600 feet in commercial and industrial areas, and 1000 feet in all other areas.
- D. Valves located between street intersections shall be located at fire hydrant branches. Only one in-line valve is required at branch fittings where needed to comply with the maximum spacing requirement of Item 2.2.1 C.
- E. Install four valves at cross fittings. Refer to Standard Detail Sheet 5050.
- F. Install three valves at tee fittings except at hydrant branches (see 2.2.1 D).
- G. Install valves on each side of services to allow for isolation, 3 inches in size and larger, to schools, hospitals and major industrial sites.
- H. Note on the plans all existing valve boxes to be adjusted to grade.
 - 1. Resilient seat gate valves are preferred.
- I. Refer to Standard Detail 5090 for the approved method of installation.

2.2.2 Fittings

- A. All joints shall safely withstand the same working pressures for which the water main is designed.
- B. All fittings shall be thrust blocked as follows:
 - 1. Concrete thrust blocks must be of adequate size. Refer to Standard Detail Sheets 5020, 5030 & 5040.
 - 2. At vertical bends where the thrust is upward, tie rods shall be used and designed to take the full theoretical tension developed under the test pressure.
 - 3. Alternate joint restraints may be used if approved by the City Engineer. (e.g., mechanical joints with constraints)
- C. Fittings shall be used for all bends of $11\frac{1}{4}^\circ$ and larger.

2.2.3 Hydrants

- A. Hydrant locations:
 - 1. Maximum spacing shall be 300 feet as measured along the face of curb.
 - 2. Locate on property lines when practical;
 - 3. Provide minimum 3 feet clearance from street light poles;
 - 4. Provide minimum 10 feet clearance from existing and proposed street trees;

5. When located near intersections, place 5 feet beyond the curb return.
 6. In cul-de-sacs, locate the hydrant at the start of the return to the cul-de-sac bulb. See Design Detail DF-2, "Standard Fire Hydrant Location on Cul-de-Sac Streets," for the preferred location.
 7. All locations are subject to the approval of the City of Dixon Fire Marshal and the City Engineer.
- B. The minimum pipeline size to serve a fire hydrant is 6 inches. A dead-end 8-inch main may serve two hydrant branches.
 - C. All fire hydrants which are privately owned need to conform to CFC and as approved by City of Dixon Fire Marshal and the City Engineer. A public easement shall be provided to the City for privately owned hydrants.
 - D. Hydrants shall be independently valved at the service main.
 - E. Blue reflective pavement markers shall be located 8 inches from the street centerline, perpendicular to and towards each hydrant. The markers shall be shown on the striping plan sheet if such a plan is required.
 - F. Refer to Standard Details 5060, 5070, 5080 & 5220 for the approved method of installation.

2.2.4 Air Relief Valves

- A. Air relief valves (ARV) shall be located:
 1. At the end of main lines, both permanent and temporary, if the pipeline rises to the termination point.
 2. At high points in main pipelines. A high point is considered to exist when the pipe slopes downwards in both directions away from the pipe and the difference in elevation, between changes in grade 500 or more feet apart, exceeds one diameter of the pipeline.
- B. Existing temporary ARVs to be removed or relocated, and new ARVs to be installed, shall be clearly shown and noted on the plans.
- C. Temporary ARVs shall be located 5 feet past the end of the roadway pavement.
- D. See Standard Detail 5150 for the approved method of installation.
- E. For pipe segments spanning 1,000 feet, air release and blow off should be placed on either side of the isolation valve.

2.2.5 Combination Air and Vacuum Valves

- A. Combination air and vacuum valves exhaust air during filling of pipe and admit air during shutdown and draining of pipe. These valves release air continuously during normal operation of pipe and prevent any surges. Use these types of air valves in all pipelines 12 inches and larger.

2.2.6 Blowoffs

- A. Blowoffs shall be located:
 - 1. At dead-end of main lines, both permanent and temporary if the pipeline descends to the termination point, and where no fire hydrant exists. A fire hydrant may be considered as a blowoff if located where a blowoff is required.
 - 2. At significant low points in main lines where directed by the City Engineer.
 - 3. Where stagnant conditions are likely to develop in pipelines isolated by normally closed valves from water flowing through the distribution system.
 - 4. At the ends of water service pipes without meter stops installed in grade boxes.
- B. Existing blowoffs to be removed or relocated, and new blowoffs to be installed, shall be clearly shown and noted on the plans.
- C. Temporary blowoffs shall be located outside of roadway pavement.
- D. See Standard Detail 5140 for the approved method of installation.

2.2.7 Sampling Stations

Locations for state-required sampling stations shall be provided by the City Engineer and noted on Improvement Plans submitted for review. The number of stations required in the City of Dixon Service Area depends upon the population being served, or the number of service connections, and is determined by City staff.

2.2.8 Main Taps

- A. "Hot taps" to be approved by City Engineer.

DS5-03. SERVICE CONNECTIONS:

3.1 Services

- A. Every developable parcel shall be provided a service connection. A single service connection shall not serve more than one dwelling unit except:
 - 1. In multi-family dwellings, where an adequately sized service line may feed multiple meters, and
- B. The minimum service pipe size shall be 1 inch to be HDPE material (iron pipe size).
- C. Services larger than 1 inch in size shall be justified by submission of the water demand on the service. 1 ½ to 2 inch HDPE material (Copper tube size) larger than 2-inch ductile iron or C-900. Installation of larger services shall be approved by the City Engineer.
- D. The location of all service lines shall be shown on the plans. Services shall be located:
 - 1. A minimum of 3 feet from the projection of the side lot line;
 - 2. A minimum of 2 feet clearance from sewer laterals;
 - 3. On the wide frontage of corner lots, or on the lesser-traveled way at intersections with arterial or collector streets;
 - 4. Not within driveway approaches. This includes service lateral pipelines from the main to the meter.
 - 5. Services shall not be connected to fire hydrant branch mains downstream of the shutoff valve.

- E. Easements for services shall extend 5 feet or more beyond the point of connection and be 10 feet wide. Services shall be located in the center of their easements.

3.2 Meters

- A. All services shall be metered. Meter sizes shall be determined in accordance with the Uniform Plumbing Code, latest edition, except as noted below.
- B. Each lot in a new residential subdivision shall be provided with a one inch meter to meet required fire sprinkler needs per the California Building Code, and as required by the City of Dixon. A ¾ inch meter may be provided at the discretion of the City. In all cases, calculations supporting the new service size shall be submitted to the City for review and acceptance prior to approval of any building or Improvement Plans.

In the event that a residential addition or remodel triggers the need for fire sprinklers, per California Building Code and as required by the City of Dixon, calculations supporting the service size shall be submitted to the City for review and acceptance prior to approval of any building or Improvement Plans.

Utilize Standard Detail 5200 for the installation of the metered service with residential fire sprinkler system.

- C. Commercial Meter Location: Meters shall be located within 5 feet of the service stub unless otherwise approved by the City Engineer.
- D. Refer to Standard Details 5100, 5120, & 5200 for the approved method of installation

3.3 Cross-Connection Control (Backflow Prevention)

- A. Cross-connection requirements are specified in the Article XI, Protection of Drinking Water, of the City of Dixon Municipal Code for Water.
- B. In general, backflow prevention assemblies are required on all services except single family residential services, including:
 - 1. Commercial and industrial services;
 - 2. Fire protection systems (both sprinkler and distribution systems);
 - 3. Landscaping irrigation systems.
 - 4. Multi-Family Residences (Apartment complexes, triplex, etc.)

Refer to Article XI, Protection of Drinking Water, of the City of Dixon Municipal Code for Water, Section 14.02.1130.B.4.f for a list of recommended minimum types of backflow protection devices. These recommendations shall be followed.

- C. All assemblies are to be:
 - 1. Designed in accordance with Article XI, Protection of Drinking Water, of the City of Dixon Municipal Code for Water.
 - 2. Listed as approved by the University of Southern California Foundation for Cross-Connection Control and Hydraulic Research.
 - 3. Installed in accordance with Standard Details 5160, 5170, 5180 & 5190.

- D. Backflow prevention assemblies are owned by the landowner, and all maintenance and repair of them is at the landowner's expense.
- E. Backflow prevention assemblies shall generally be located as follows:
 - 1. To protect the water system, locate BFPs immediately after (downstream of), and as close as practical to, the water meter.
 - 2. To protect them from physical damage, locate BFPs:
 - a. Immediately behind the back of the sidewalk for 2 inches and smaller BFPs;
 - b. Ten feet behind sidewalks in landscaping areas, and 5 to 6 feet from driveways for 3 inch and larger BFPs.
 - 3. Locate BFPs at the center of their easements.
- F. The proposed location of Reduced Pressure Detector Assemblies (RPDA) shall be approved by the City Engineer.
 - 1. To protect the RPDA from physical damage, locate it 10 feet behind sidewalks in landscaping areas, and 5 to 6 feet from driveways.
 - 2. Locate RPDAs at the center of their easements and as near as practical to the service stub.
- G. Access to all backflow prevention assemblies must be provided so that annual testing may be safely and easily accomplished by an American Water Works Association certified cross-connection backflow tester.

DS5-04. WATER SUPPLY FACILITIES:

4.1 General

Water supply facilities include municipal supply wells, storage and hydropneumatic tanks, booster pump stations, and associated equipment for their use and operation. The City of Dixon water system uses these facilities to extract and pump groundwater into the distribution system.

The criteria listed below are for designing City of Dixon water supply facilities. All water supply facilities shall be built to current state and City specifications, which are provided in the City of Dixon Construction Standards. Additional specifications will be provided by the City Engineer as necessary for inclusion in construction documents.

Construction will be inspected by the City of Dixon for compliance with its specifications. Design review, inspection and other oversight of supply facility design and construction shall be at the developer's expense.

4.2 Site Requirements

A. Site Area and Dimensions

1. Well, Tanks and Booster Facilities:

The site layout is to be rectangular and shall meet, the minimum dimensions shown on Drawings DF-4, DF-5, and DF-6. Single tank sites shall be sized to allow for a future second tank. See Design Details DF-4 and DF-5 for typical layouts and minimum dimensions. Provide a minimum of two driveways into the site and access through the site so well rigs can be positioned around the well

and all equipment can be accessed and maintained. Actual design shall be on a site by site basis and must be approved by the City Engineer in writing.

2. High Pressure Municipal Supply Well Facilities:

Provide an open area of at least 20 feet wide by 50 feet long on each side of the well casing. These are needed for location of cranes and trailers used in well maintenance. The open areas should be in-line and opposite each other. Provide a minimum of two driveways into the site so well rigs can be positioned around the well. The total site area shall be 0.3 to 0.4 acre. Typical dimensions are 100' x 110'. See Design Detail DF-6 for a typical layout. Municipal supply well sites shall be adequately sized to accommodate wellhead treatment.

3. Requirements for Additional Area

If some of the site will be unusable (such as areas containing creeks), the site area must be increased to offset the unusable area. Passage of other public utilities through the site in their own easements, and setback requirements on the site that prevent some of it from being fenced or used, add additional area and separation requirements. A more detailed review can be made on alternative dimensions, but a tentative site layout will be required, at the developer's expense.

B. Site Locations

Each water supply facility shall be sited based on consideration of applicable regulations and requirements and defined facility-specific siting needs. Municipal supply wells shall be sited in accordance with the State of California Code of Regulations Title 22, Division 4, Chapter 16, Article 3, Section 64560, "New Well Siting, Construction, and Permit Application", State Water Resources Control Board Division of Drinking Water (DDW) requirements and Solano County Resource Management Department Well Standards. Site locations are subject to review and approval by DDW.

C. Site Access Requirements

Each facility shall be provided dual access from adjacent public rights-of-way, which shall conform to applicable City standards in all respects, including alignments, dimensions, clearances and surfacing. Adequate space must be provided for vehicular drive through access to facilities. Access for trailer-mounted drilling and pump column-removal equipment shall be provided at municipal supply well sites.

D. Grading and Drainage

Before the final site elevation is set, the drainage patterns of flood flows in the area should be determined, and the lowest site elevation set one foot above the probable high-water elevation. The site should be sloped upwards from this elevation to provide proper on-site drainage. The water supply equipment should be located at or near the high point.

E. Clearances between Structures and Equipment

At least 42 inches clearance around all equipment is required. Manufacturer-required clear zones for maintenance are in addition to the minimum 42 inches.

F. Lighting

Provide lights at the well, the electrical building door, and the chlorinator.

G. Sound Control

If the well is located in a residential area, a sound enclosure will be required. Noise levels are established by the City of Dixon Community Development Department.

H. Fencing

Fence shall be 8 feet tall block wall with razor topper. Use of chain link fencing must be approved by City Engineer. Gates shall be single panels, 20 feet wide roller gates (preferred) or alternatively 20 foot swing gates opening into the compound. Dual access required for circulation.

I. Landscaping

Landscaping shall be designed to blend with existing landscaping as much as possible, and shall be planted outside of the fenced compound. Non-deciduous and water conserving plants are preferred. Automatic irrigation systems shall be included. Landscaping shall be maintained by the City of Dixon City Engineer.

J. Typical Facilities

Design Details DF-4 and DF-5 show typical Well, Tanks and Booster Facilities. Actual facilities may be designed differently as long as they meet City requirements. Site design shall be subject to the approval of the City Engineer.

4.3 Equipment Requirements

A. Municipal Supply Wells

1. Municipal supply wells shall be drilled, constructed, developed and tested in accordance with the State of California Waterworks and Well Standards, applicable sections of the California Code of Regulations, Solano County Resource Management Department Well Standards, City of Dixon Municipal Code for Water requirements, and applicable AWWA, ASTM, NSF/ANSI 60, and NSF/ANSI 61 standards. Municipal supply wells shall have sanitary seals with a minimum 50-foot depth, around their casings per state and county standards. Deeper sanitary seals with a depth potentially greater than 400 feet (due to agricultural contaminants of the shallow groundwater) shall be required when needed to protect municipal supply wells from shallower groundwater with degraded quality. Wells shall be gravel packed using appropriately size-graded material conforming to AWWA standards. Casing and screen shall meet applicable ASTM standards. Well screens shall be factory-fabricated louvered or wire wrapped.
2. The use of mud pits during well drilling shall not be allowed.
3. The minimum design production capacity for a municipal well in the City system is 1,500 gallons per minute. If pumping into a storage tank, well pumps must develop sufficient pressure to fill the tank at its site. Well pumps that pump directly into the distribution system must generate the maximum current system pressure and must be confirmed before finalizing the well design.
4. Municipal supply wells shall be designed and constructed to include pump to waste capability to support operation and maintenance requirements.
5. Municipal supply well design shall be based on a test boring or multiple completion monitoring well to a depth of at least 1,500 feet below ground surface. Information from the test boring or multiple completion monitoring well will be used to identify productive zones that meet

drinking water standards and achieve a yield of 1,500 gpm. The preference is to design the well to meet all drinking water standards without treatment. If required, the information shall be sufficient to design the required treatment system.

6. Pump controls.
 - a. Reservoir – As the water level in the reservoir drops or rises, sensors signal the pump control box to start or stop.
 - b. Distribution System Pressure – Must generate the maximum current system pressure and must be confirmed with City Operations before finalizing the pump control design.
 - c. SCADA – A programmable logic controller (PLC) interface between the storage tank instruments and the central control system. The storage tank remote terminal units (RTU) is programmed in accordance with the storage tank's control strategy which should be prepared by the design consultant.
 - d. Well pumps – Well pumps shall be centrifugal pumps, with solid shaft, rotor with impeller keyed or press-fit on it. The casing, shaft and impeller are made from alloy steel forging.
 - e. Diesel generator – Diesel generator should be capable of running 72 hours continuously. The generator should have sound barrier arrangement to meet the noise ordinance requirements at project property line. It also needs automatic transfer switch.
 - f. Municipal supply wells pumping directly into the system shall be provided with variable frequency drives. Those pumping into storage tanks shall be provided with constant speed motors. The suction line should extend at least 5 feet below the pumping water level and be about 10 feet above the well bottom.
 - g. Pumps shall be housed in a building adjacent to the municipal supply well.

B. Hydropneumatic /Surge Tank

1. Each well directly connected to distribution system shall be equipped with a hydropneumatic tank, check valve/meter manifold, liquid/tablet chlorinator, electrical control building, PG&E transformer, and a diesel-powered emergency electrical generator.
2. A hydropneumatic tank shall be installed on the outlet of each pumping plant. The hydropneumatic tank or surge protection tank must include all controls and appurtenances, including air volume control system and air charging system, supplied by a single vendor as unit responsibility.

C. Water Storage Tanks

1. Water storage tanks shall be welded steel and shall be designed and constructed in accordance with AWWA D-100 (Welded Carbon Steel Tanks for Water Storage), ASCE 10 (Minimum Design Loads and Associated Criteria for Buildings and Other Structures), and the California Code of Regulations Title 22 Chapter 16, Article 6 (Distribution Reservoirs).
2. Tanks shall have separate inlet and outlet piping as required by CCR Title 22 §64585(b)(4). Piping shall be placed through the bottom of the tank. Recirculation piping and pumps shall be provided to afford additional circulation in the storage tank. The pumping system shall be designed to recirculate the entire volume of the storage tank in 3 days.
3. The tank foundation shall consist of a reinforced concrete ring. The top of the ring wall footing shall be a minimum of 6 inches above finished grade. The minimum depth of the ring wall footing below the bottom of the tank is not less than 2 feet. A geotechnical investigation shall be conducted at the site of the tank structure with at least one boring located at the center of the proposed tank and to a depth of 75 percent of the tank radius or a minimum depth of 60 feet.

- The number of borings and associated depth shall be approved by the City Engineer prior the beginning of the geotechnical field investigation.
4. An emergency fill connection to the distribution system shall be provided within the facility compound and immediately adjacent to the tank. The emergency fill connection shall be valved and controlled automatically with a supervisory control and data acquisition (SCADA) system.
 5. Accessories shall include a secured roof access, stairs, overflow pipe and drains.
 6. Access to antennas and related equipment should comply with Occupational Health and Safety Administration (OSHA) regulations. This may require a safety rail around the installation, anchor points on the tank roof for personnel tie-off, ladders, or other fall-prevention devices.
 - a. Roof Vent shall be provided and located near center of the tank.
 - b. Vent capacity shall be equal to the maximum flow rate of water entering or exiting the tank without developing excess pressure.
 - c. Vent shall be screened with a stainless-steel mesh.
 7. Vent shall be pressure-vacuum vent or a separate pressure-vacuum relief mechanism shall be provided.
 8. Tank drain at bottom of tank (not the manway) and where it discharges (storm drain). Discharge should be dechlorinated prior to release into the storm drain system.
 9. Seismic anchor – Anchor bolts are used to resist safely the seismic force and the uplift resulting from the overturning moment about the axis of the base of the tank. Anchor bolt nuts are torqued after filling the storage facility. Anchor bolts shall be included in accordance with AWWA D100.
 10. Interior/exterior coating shall be in accordance with AWWA D102.
 11. Water Quality – A disinfection system shall be included and chlorine residual level shall be monitored continuously.
 - a. Disinfection Type: Sodium Hypochlorite.
 - b. The disinfection system shall be housed in separate room within the pump station building. The design should include chlorine analyzers, sampling ports and a flanged connection for chlorine injection.
 12. Tank sampling ports for water quality – Four (4), 3/4-inch sample taps shall be provided at the following levels.
 - a. Three points protrude one foot into the tank and separated vertically to represent water quality from the bottom to the top of the tank.
 - b. A fourth sample point located at the bottom, flush with the inside face of the tank.
 13. Signed and stamped calculations from design engineer registered in the State of California.
 14. Cathodic protection - at a minimum the corrosivity study should be performed to determine if cathodic protection is required. Study shall be performed by NACE certified.
 15. Provide visual level indicator on exterior of tank.
 16. SCADA – Water storage tank level, sodium hypochlorite storage tank levels, chlorine feed pump status/fail, and chlorine residual levels.

D. Pumping Stations

1. The discharge manifold of each pumping station (both wells and booster pumps) will be metered and teed directly into the 12" distribution pipe grid so as to provide two 12" flow paths into the grid. In other words, such facilities will not be located at the end of a 12" branch line or discharge into one 12" and one 10" pipe, etc.

2. Pumps and electrical equipment shall be housed in weatherproof buildings. The prevailing architectural style of buildings includes split-face block walls, metal doors, and wood truss-framed roofs with tile roofing.
3. Each pumping station shall be equipped with a PG&E service (which typically requires an on-site transformer) and a diesel-powered emergency electrical generator. All electrical equipment shall conform to the National Electrical Code (NEC).
4. Pumps, valves and pipings shall be designed, selected, constructed and tested in accordance with the American National Standard Institute/Hydraulic Institute (ANSI/HI), American Bearing Manufacturers Association (ABMA) and International Organization of Standardization (ISO).

4.4. Well Abandonment

Abandon and destroy water wells in accordance with the provisions of DDW and County Public Health Department Standards. Provide a Water Well destruction plan prepared by a registered engineer or certified hydrogeologist. The primary purpose of the plan shall be to prevent groundwater movement, utilizing the existing well structure, between the various underground aquifers as well as prevent the direct movement of surface water into the underlying aquifer. The well destruction plan will be reviewed and approved by the City Engineer prior to commencement of work.

DS5-05. SPECIAL CONSIDERATIONS:

5.1 Landscape Irrigation Services

Services shall be located near a 110 VAC power source for the irrigation controller. RP assemblies shall be provided for each landscaping irrigation service.

5.2 Fire Protection Services

Calculations of water service requirements shall be submitted for review by City's Fire Marshal.

5.3 SID Irrigation Facilities

Existing facilities of the Solano Irrigation District (SID) shall be protected, relocated, taken out of service or removed as directed by SID in review comments. All work done on SID facilities shall be in conformance with the SID Standard Specifications and Details. No work can be done on water systems to be maintained by SID without the approval of the plans and details by the SID Engineering Department.

5.4 Rights-of-way

Proof of existing rights-of-way shall be submitted to the City of Dixon for review and approval a minimum of 60 days prior to commencement of construction. Easements for water system facilities shall be a minimum of 30 feet wide for 8 inch pipes and 40 feet wide for 12 inch and larger (except for services and BFPs as noted above), with the main or appurtenance offset 6 feet from the centerline of the easement. On-site interior water lines outside the public right-of-way and not protected by backflow prevention devices shall be owned and maintained by the City, and shall require an easement dedicated to the City of Dixon.

DS5-06. DESIGN SUBMITTAL REQUIREMENTS:

6.1 Special Designs

- A. Water demand for services larger than one inch in size.
- B. Locations of RPDA assemblies for fire protection systems.
- C. Fire protection system calculations, stating the following supply requirements: pipe size, design supply pressure, design flowrate, booster pump size, inlet head requirements, and curves.
- D. Pipe supports.
- E. Railroad crossings (bored casings) and similar measures.

6.2 Approvals

No work can be performed on City water systems without an approved set of plans.

6.3 Typical Review Process

- A. Three (3) copies of Improvement Plans shall be submitted to the City of Dixon City Engineer, with accompanying calculations, tentative or final subdivision maps, and other data necessary for review of the proposed design.
- B. When the complete plans are acceptable, an original set shall be submitted to the City of Dixon for signature. Four (4) sets of prints and a reproducible set of the approved plans shall be submitted to the City of Dixon City Engineer prior to commencement of work. Additionally, electronic plan set files shall be submitted, including AutoCAD files (or other design software) and pdf files.

6.4 Addresses

- A. City of Dixon City Engineer

Mail:

600 East A Street

Dixon, CA 95620

(707) 678-7030

FAX (707) 678-7039

Physical Address:

171 South Fifth Street

Dixon, CA 95620

This Page Intentionally
Left Blank

DETAIL NOT USED



CITY OF DIXON
ENGINEERING
STANDARD DETAIL



APPROVED: MARCH 2022

TYPICAL SIGNATURE
BLOCK

DF-1

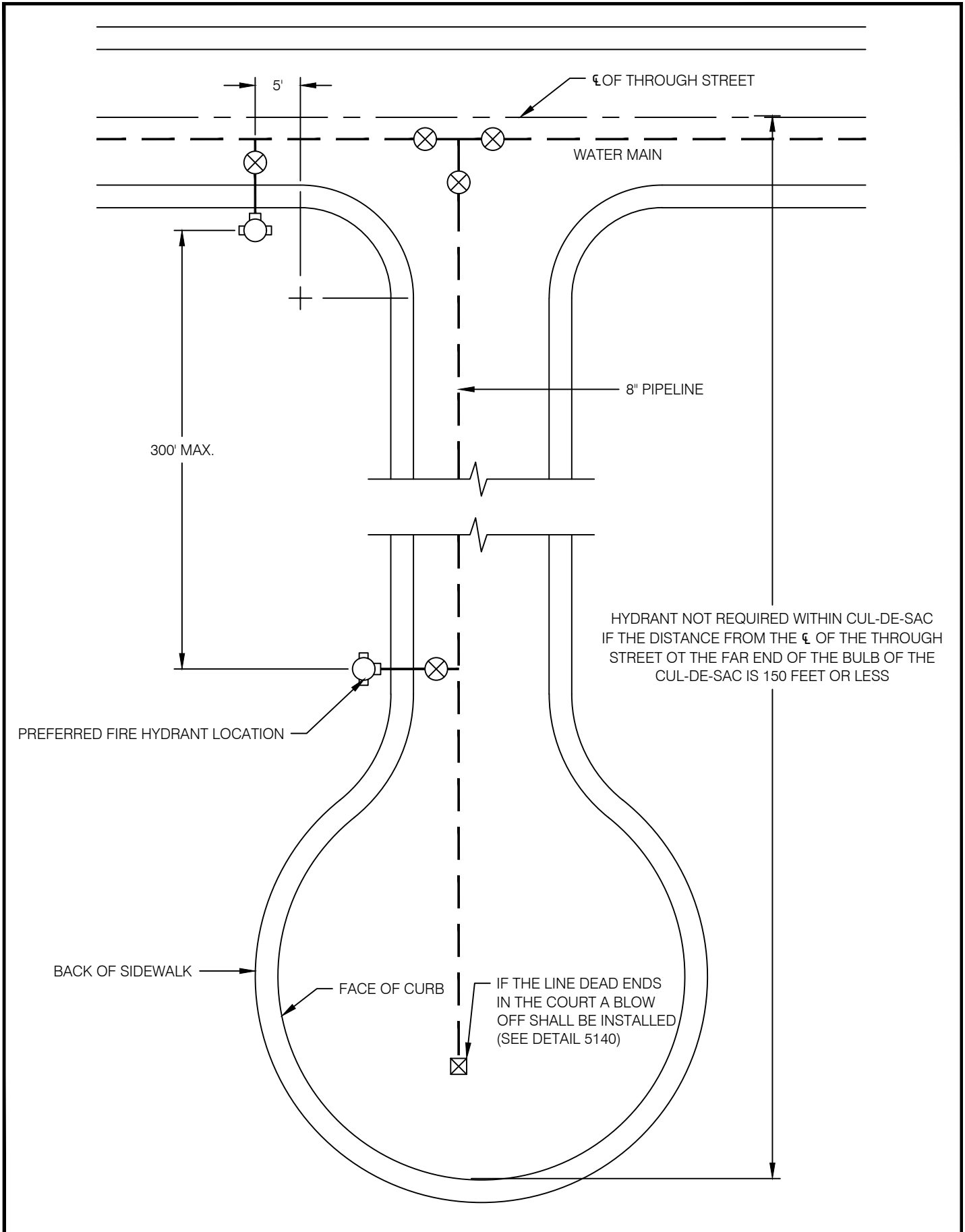

DF-2

STANDARD FIRE
HYDRANT LOCATION
ON CUL-DE-SAC
STREETS



APPROVED: MARCH 2022

CITY OF DIXON
ENGINEERING
STANDARD DETAIL



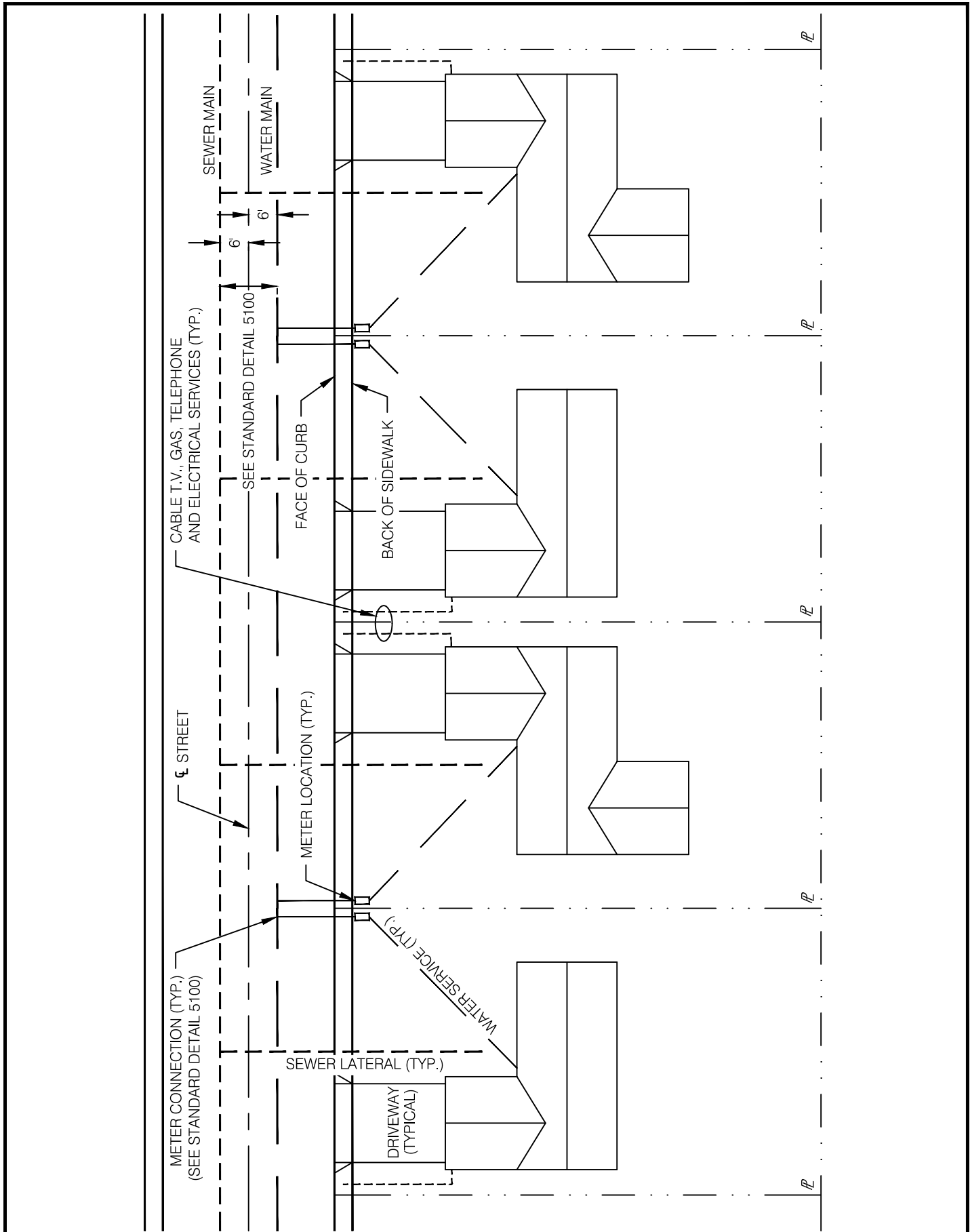

CITY OF DIXON
 ENGINEERING
 STANDARD DETAIL



APPROVED: MARCH 2022

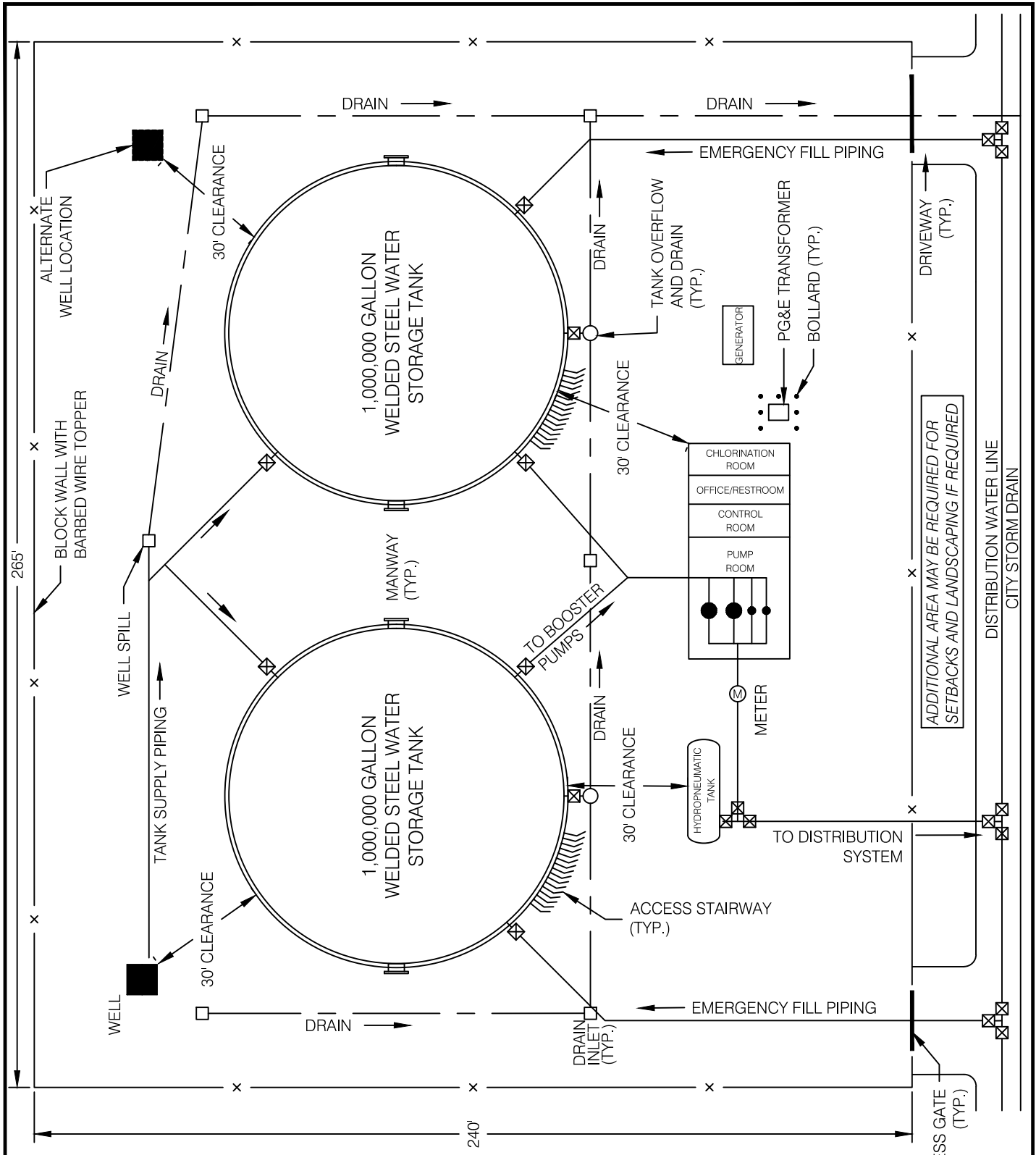

**TYPICAL LOCATION
 OF SERVICE
 CONNECTION**

DF-3



NOTES:

1. THE PROPOSED LAYOUT IS AN EXAMPLE TO PROVIDE THE MINIMUM ATTRIBUTES TO BE INCLUDED AT A WATER TANK FACILITY. THE ACTUAL DESIGN SHALL BE DESIGNED ON SITE BY SITE BASIS AND APPROVED BY THE CITY ENGINEER.
2. DUEL ACCESS REQUIRED TO THE FACILITY W/ INTERNAL TRUCK ACCESS/CIRCULATION.
3. UTILITY CONNECTIONS TO MEET WATER, SEWER, STORM REQUIREMENTS.

DF-4	TYPICAL TWIN 1,000,000 GALLON TANK SITE		CITY OF DIXON ENGINEERING STANDARD DETAIL	
		APPROVED: MARCH 2022		

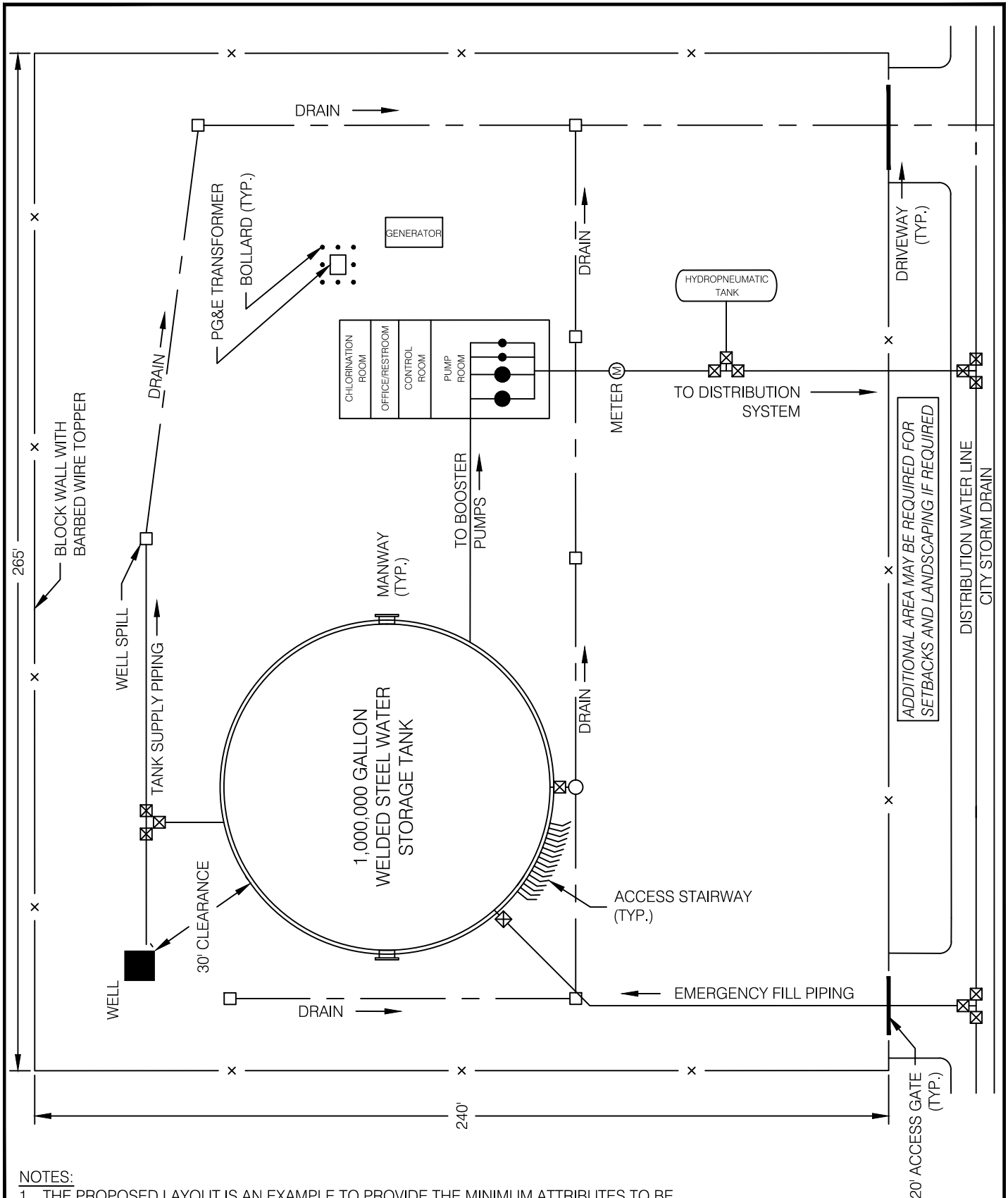

NOTES:

1. THE PROPOSED LAYOUT IS AN EXAMPLE TO PROVIDE THE MINIMUM ATTRIBUTES TO BE INCLUDED AT A WATER TANK FACILITY. THE ACTUAL DESIGN SHALL BE DESIGNED ON SITE BY SITE BASIS AND APPROVED BY THE CITY ENGINEER.
2. DUEL ACCESS REQUIRED TO THE FACILITY W/ INTERNAL TRUCK ACCESS/CIRCULATION.
3. UTILITY CONNECTIONS TO MEET WATER, SEWER, STORM REQUIREMENTS.



CITY OF DIXON
ENGINEERING
STANDARD DETAIL



APPROVED: MARCH 2022

TYPICAL 1,000,000
GALLON TANK SITE

DF-5

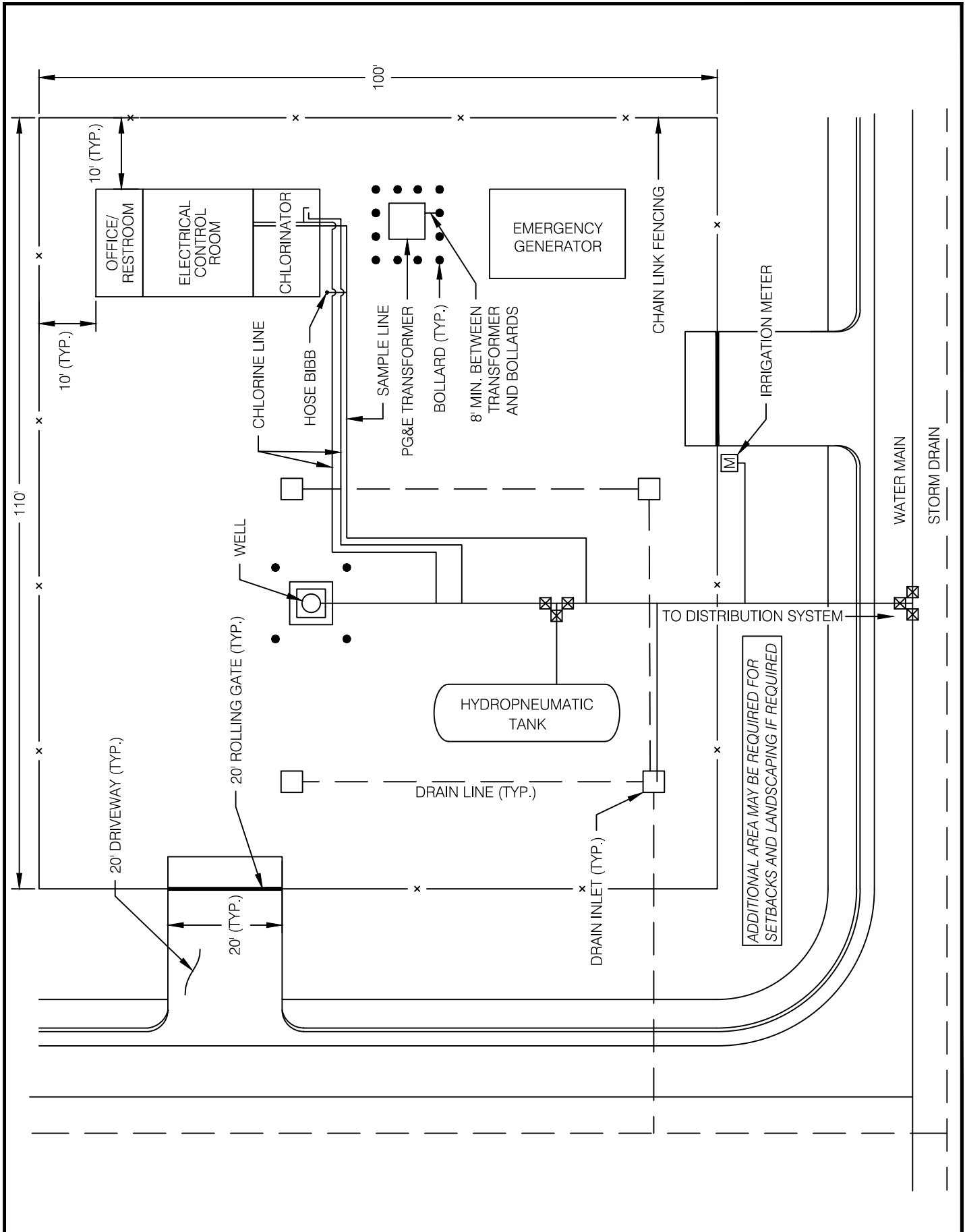

DF-6

TYPICAL DIRECT
FEED WELL
FACILITY



APPROVED: MARCH 2022

CITY OF DIXON
ENGINEERING
STANDARD DETAIL



ENGINEERING DESIGN STANDARDS

SECTION 6 – SANITARY SEWER DESIGN

DS6-01. GENERAL: Sanitary sewer improvements shall be designed to serve the ultimate level of development as defined in the City General Plan. All improvements shall conform to the requirements of the Solano County Health Department, the Uniform Plumbing Code, and the City of Dixon Engineering Design Standards and Construction Specifications.

DS6-02. PLAN REQUIREMENTS: Sanitary sewer improvement plans shall show geometric designs in both plan and profile views. Required information shall be main and lateral sizes and slopes, utility crossings, manholes, cleanouts, invert elevations, and any calculation used in the design of the system.

DS6-03. DESIGN:

- A. Flow - The design sanitary sewer flow in gallons per day (gpd) shall be calculated using the following formula:

$$Q_d = Q_p + I \& I, \text{ where}$$

Q_d = Design flow

Q_p = Peak flow = Average Daily Flow x Peaking Factor

I+ I = Infiltration & Inflow Factor

The average daily flow rates and the I+I (Infiltration & Inflow) factors for various land uses are shown in the following table:

DESIGN FLOWS		
LAND USE	AVERAGE DAILY FLOW	I+I FACTOR
Single-Family	250 gpd per unit	500 gpd per gross acre
Multi-Family	3,600 gpd per net acre	500 gpd per gross acre
Commercial/Public	1,100 gpd per net acre	500 gpd per gross acre
Industrial	1,400 gpd per net acre	500 gpd per gross acre
Schools	3,600 gpd per net acre	500 gpd per gross acre

*Note: Net Acres is assumed as 80 percent of Gross Acres.

The peaking factors to be used to calculate the peak flow are shown in the following table:

PEAKING FACTORS	
SHED AREA	PEAKING FACTOR
Shed area less than 500 acres	2.5
500 acres □ Shed Area □ 1,500 acres	2.2
Shed area greater than 1,500 acres	2.1

- B. Pipe Capacity - Typically sewer mains shall be sized based upon the sewer flowing at 70 percent of pipe capacity using the following formula:

Manning's Formula: $Q = A(1.49/n)(R^{2/3})(S^{1/2})$, where

Q = Flow, in cubic feet per second (cfs)

A = Area of Pipe in square feet (sf)

R = Hydraulic Radius (Area/ Wetted Perimeter)

S = Slope of Pipe

n = Roughness of 0.013 or as recommended by the pipe manufacturer, whichever is greater

Pipe capacity, in all cases, shall be adequate to carry the design flow from the entire tributary area, even though said tributary area is not located within the project boundaries. Sewer trunk line design criteria shall be done on a case by case basis, as approved by the City Engineer.

- C. Velocity - Sewer velocity shall be equal to or greater than 2 feet per second for all sewers when flowing full with a maximum velocity of 10 feet per second. Sewers which will exceed 50 percent capacity at ultimate development shall have their minimum design slope determined using a minimum velocity flowing full of 2 feet per second. Sewers which will not exceed 50 percent capacity at full development shall have a minimum design velocity flowing full of 2.5 feet per second.
- D. Main Size - Minimum size sewer main shall be 8 inches with a minimum slope of 0.0052 percent.
- E. Sewer Pipe Type - Typical sanitary sewers shall be constructed of extra-strength vitrified clay pipe (ESVCP). SDR35 polyvinyl chloride pipe (PVC) material may be used in residential areas, on a case by case basis, upon approval by the City Engineer. PVC pipe consideration will require a design and construction analysis using ASTM Specifications for the pipe material. A report will be submitted identifying all design and construction criteria per ASTM Specifications.
- F. STUDY MAP - A study map may be required prior to review of the sewer design if there is a possibility that upstream or adjacent areas might require service through the subject property. The map should show the entire service area including upstream tributary and adjacent areas, and all other data necessary to determine anticipated service area, including pipe sizes and slopes, shall be shown to the extent necessary to determine the requirements within the subject property. Any required study map shall be paid for by the project developer; however, said study map may be waived by the City Engineer if previously performed.

DS6-04. VERTICAL ALIGNMENT:

- A. At all manholes where a change of direction of more than 20 degrees occurs, the flow line of the upstream main shall be 0.20 ft. above the flow line of the downstream main.
- B. Where a change in size of mains occurs, the crowns shall be matched.

- C. No vertical curves shall be allowed.
- D. Where minor mains connect to trunk mains, the crowns shall match if feasible. Under no circumstances shall the invert of the minor main enter the trunk main below springline.

DS6-05. HORIZONTAL ALIGNMENT:

- A. All sanitary sewers shall be installed in the pavement area of the street. Generally the location should be 6 feet from the center line of the street, on the opposite side of the centerline from the water line.
- B. Under special circumstances, if approved in advance of plan submittal, exception may be granted by the City Engineer which will allow a sanitary sewer line to be placed in an easement. In such cases, a minimum 15 foot wide easement shall be given, and the easement shall cross not more than one lot. Deeper lines shall require a wider easement to the satisfaction of the City Engineer.
- C. Location in existing streets - The following shall be considered: location of curbs, gutters, and sidewalks; traffic lane configurations; future street improvement plans; and existing utilities.

DS6-06. SEWER MAIN CLEARANCES: Clearances between sanitary sewer mains and other facilities shall conform to state law, but shall not be less than:

- Horizontal: 10 feet minimum from any water line
5 feet minimum from all other facilities
- Vertical: 1 foot minimum from all facilities for main lines
6" minimum from all facilities for service laterals

DS6-07. APPURTENANCES:

- A. Manholes - Normal maximum spacing for manholes shall be 400 feet. Where the location of two manholes is determined by intersecting lines, the distances between intervening manholes shall be approximately equal. Sewers on curved alignments with a radius of less than 400 feet shall have manholes spaced at a maximum of 300 feet on the beginning and ending of the curve and adjusted to fit the individual case. The spacing of manholes on trunk sewer lines 12 inches and larger in diameter shall be proposed for each individual case and shall be approved by the City Engineer. All manhole connections of trunk lines 12-inch and larger shall be epoxy-coated to reduce inflow & infiltration. Manholes shall also be located at all change in pipe sizes and slopes, and at angles of 20° or more in alignment. Manholes shall also be placed at the termination of all sewer mains including those lines which may be extended in the future and cul-de-sacs. Services to adjacent properties within the cul-de-sac should be connected to this manhole.
- B. Drop manholes will be allowed upon approval of the City Engineer. Change in sewer pipe invert through a manhole is not to exceed 2 feet on an 8 or 10 inch sewer main.
- C. Cleanouts - Cleanouts on sewer main lines shall not be used. Cleanout spacing on sewer laterals shall not exceed 100 feet within the City right-of-way. Cleanouts shall be placed at all changes of size, slope, or angle points greater than 20 degrees; at intersections of mains; and at service connections where service lines are 6-inch and larger.

DS6-08. SERVICE LATERAL:

- A. GRADIENT: Four inch (4") sewer services shall have a minimum slope of 2 percent.
- B. LOCATION AND ALIGNMENT: Sewer services shall be at right angles or radial to street right-of-way. The location shall be stationed on the plans. Services shall be located near the center of each parcel, however not located within driveways, and shall be not less than 10 feet from water services, fire hydrants, street lights, etc. In cul-de-sac bulbs services should enter manholes.
- C. SIZE: Minimum size for single-family dwellings is 4-inch. Minimum size for commercial, apartments and industrial developments shall be 6 inches.
- D. DEPTH: Sewer services shall have 5-foot to 5-foot, 6-inches of cover at the right-of-way line, and 12 inches at any buildable location within the properties to be served.
- E. CLEANOUTS: Cleanouts shall be installed on the service lateral at the back of sidewalk as shown on the Construction Details.
- F. IDENTIFICATION: Sewer laterals shall be identified with an "S" stamped or etched on the top of curb.
- G. CONNECTIONS TO LARGE MAINS: Sewer service may be directly connected to sewer mains smaller than 12 inches in diameter. For trunk sewer lines 12 inches and larger in diameter, or more than 15 feet in depth, the service sewer may be directly connected only with the approval of the City Engineer.
- H. TYPE OF PIPE: Same as sewer mains. Cleanout assemblies and service to site from the cleanout may be ABS per Construction Detail 6020.
- I. ON-SITE CONNECTIONS: Storm runoff shall not be designed to enter the sanitary sewer system.
- J. Each parcel within commercial and industrial districts, including multi-family development service laterals, shall connect to a sewer main manhole unless approved otherwise by the City Engineer.

DS6-09. TRENCH LOADING: For sanitary sewer lines over 10 feet deep, Marston's formula shall be used to determine the load placed on the pipe by backfill. The procedure for rigid pipe is described in the ASCE Manual of Engineering Practice No. 60, the Clay Pipe Engineering Manual, and in similar handbooks. The Design Engineer shall determine the factor of safety. Only the three edge bearing strength of the pipe shall be used in the computations for rigid pipe. The minimum trench width shall be O.D. plus 12 inches.

DS6-10. BEDDING AND INITIAL BACKFILL: Bedding types and factors for V.C.P. shall be as per Construction Details 3280 and 3290. For other materials, the trench width, bedding, and initial backfill shall be consistent with the pipe manufacturer's requirements. Bedding and initial backfill type shall be as necessitated by depth of cover over the pipe, trench width, pipe strength, and other factors used to determine safe pipe loading. Any special backfill requirements shall be noted on the plans.

DS6-11. LIFT STATIONS: Lift stations shall not be permitted unless specifically approved by the City Engineer in advance of plan submittal.

DS6-12. UNUSUAL DESIGN: Special designs of sanitary sewer facilities or other unusual features or structures will require individual study and approval by the City Engineer.

ENGINEERING DESIGN STANDARDS

SECTION 7 – STREET LIGHT DESIGN

DS7-01. DESIGN STANDARDS: The Design Engineer shall show the proposed street lighting system on improvement plans which meet the City of Dixon standards for public improvement plans. Unless an exception is granted by the City Engineer, the street lighting plan shall be shown on a separate plan sheet. Proposed street light locations shall also be shown on the overall site plan.

The Street Lighting Plan Sheet shall show the following:

1. Location of electroliers
2. Location of service points
3. Location of conduit and pull boxes
4. Luminaire wattage, distribution type number, and pole numbers
5. Mounting height and arm lengths
6. Wire sizes
7. Right-of-way lines and easements

All lighting systems shall be designed in accordance with accepted engineering principles, P.G.& E. drawing number 025455, Guide for Design of Street Lighting, etc., Sheets 1-7, the National Electric Code, and these standards.

For all projects which will include the construction of street lighting, the developer should contact the City Engineer early in the design process and start coordination with P.G.&E. regarding providing service to the expanded street light system. Street light identification numbers are to be assigned by P.G. & E. and should be shown on the Plan Sheet.

All street lights and the lighting systems shall be dedicated to the City upon satisfactory installation by the developer.

DS7-02. DESIGN CRITERIA: Design and placement for single arm street lights shall be in accordance with the following: Refer to Detail 7030 for double arm street lights.

Type	Street Classification	Spacing	Wattage	Nom. Mounting Height	Lumens
A	Residential	200'-250'*	70	28'	6300
B	Collector	200'-250'*	100	28'	9000
C	Arterial	150'-200'*	200	28'	18000
D	Industrial	200'-250'*	70	28'	6300
E	State Highway	150'-200'*	200	28'	18000

* See Figure 7-1A, 7-1B, & 7-1C.

All intersections shall be lighted. In the case of two different classifications of streets intersecting, the higher wattage requirement of the two streets shall prevail. All electroliers shall be controlled by a photoelectric cell.

DS7-03. LOCATIONS: The maximum spacing as listed above shall correspond to spacing for lights along the roadway. Typical street light locations are shown in Figures 7-1A through 7-1C. Additional placement criteria are given below.

For "Tee" intersections, an electrolier should be located on the through street, at or near the projected centerline of the intersecting street. For cul-de-sacs, an electrolier should be located within the bulb. (See Figure 7-1A).

Electroliers shall be located at property lines and/or curb returns. The electrolier shall be centered 30 inches behind the back edge of sidewalk when sidewalk (see Construction Detail 7010). Normally, the electroliers will be staggered on opposite sides of the street.

Any adjacent tree planting shall be coordinated such that a minimum 25' clearance shall be achieved at full canopy of planting.

DS7-04. INFORMATION FROM P.G. & E.: Once the electrolier locations have been established and approved by the City, an electronic set of plans showing the locations should be sent to P.G. & E. by the Design Engineer. The following data should be requested:

1. Service Point (Service Box or Pole/Transformer Location)
2. Electrolier Numbers

(When this information is received from P.G. & E., it shall be placed on the plans by the Engineer.)

DS7-05. CONDUIT: Electrolier conduit shall be shown on the plans in plan view and in the typical section for the street. The street light conduit may be in the "joint utility" trench or a separate trench at 6 inches from B.E.W. Conflicts with water services should be avoided but when necessary to cross a water service location, the conduit may be tucked just under the back edge of walk. Conduit shall be a minimum 1-1/2 inches Schedule 40 PVC.

DS7-06. PULL BOXES: Pull boxes shall be installed where splices are to be made between light standards and where service from a PG&E service point must be split. Pull boxes are required for each electrolier. Additional pull boxes are required for conduit runs over 300 feet.

DS7-07. CIRCUIT: Circuit locations and service points shall be shown on the Street Light Plan. Each circuit shall have no more than seven lights. Lights on opposite sides of the street shall be on separate circuits to maintain sufficient lighting in the case of a tripped circuit breaker.

DS7-08. POLES AND ARMS: Pole heights shall be specified on the plans based on the final mounting height required for the roadway classification. (See DS7-02)

Arm lengths shall be specified on the plans such that the luminaire is mounted approximately over the gutter flow line. Generally a six foot arm should be used when the pole is 7 feet to 8 feet from the flow line. Pole locations shall also be shown on the Site Plan Sheet to ensure that other improvements do not interfere with proposed street light locations.

DS7-09. WIRE: Service conductors shall be minimum No. 8 AWG. Larger sizes may be required for longer circuits with more lights. All street light standards shall be wired with copper wire, moisture and heat resistant thermoplastic insulation (THW) or equal, minimum No. 12 AWG. Where larger wire sizes

are required due to heavy electrical loads, they shall be sized in conformance with the National Electrical Code requirements.

DS7-10. SERVICE: A 120-volt underground electrical service shall be provided for each street lighting system through a Caltrans standard Type III AF unmetered service pedestal. Refer to the latest edition of the State of California Standard Plans' Detail for Type III-A Series for further detail. Separate circuit breakers shall be provided for each circuit. A maximum of seven (7) street lights shall be designed on any given circuit. Other voltage circuits (i.e.; 208 volt) may be approved by the City Engineer in unusual situations. Service pedestals shall be provided within a utility easement and shall be easily accessible from the street frontage.

DS7-11. LIGHTING. All lights shall be LED.

This Page Intentionally
Left Blank

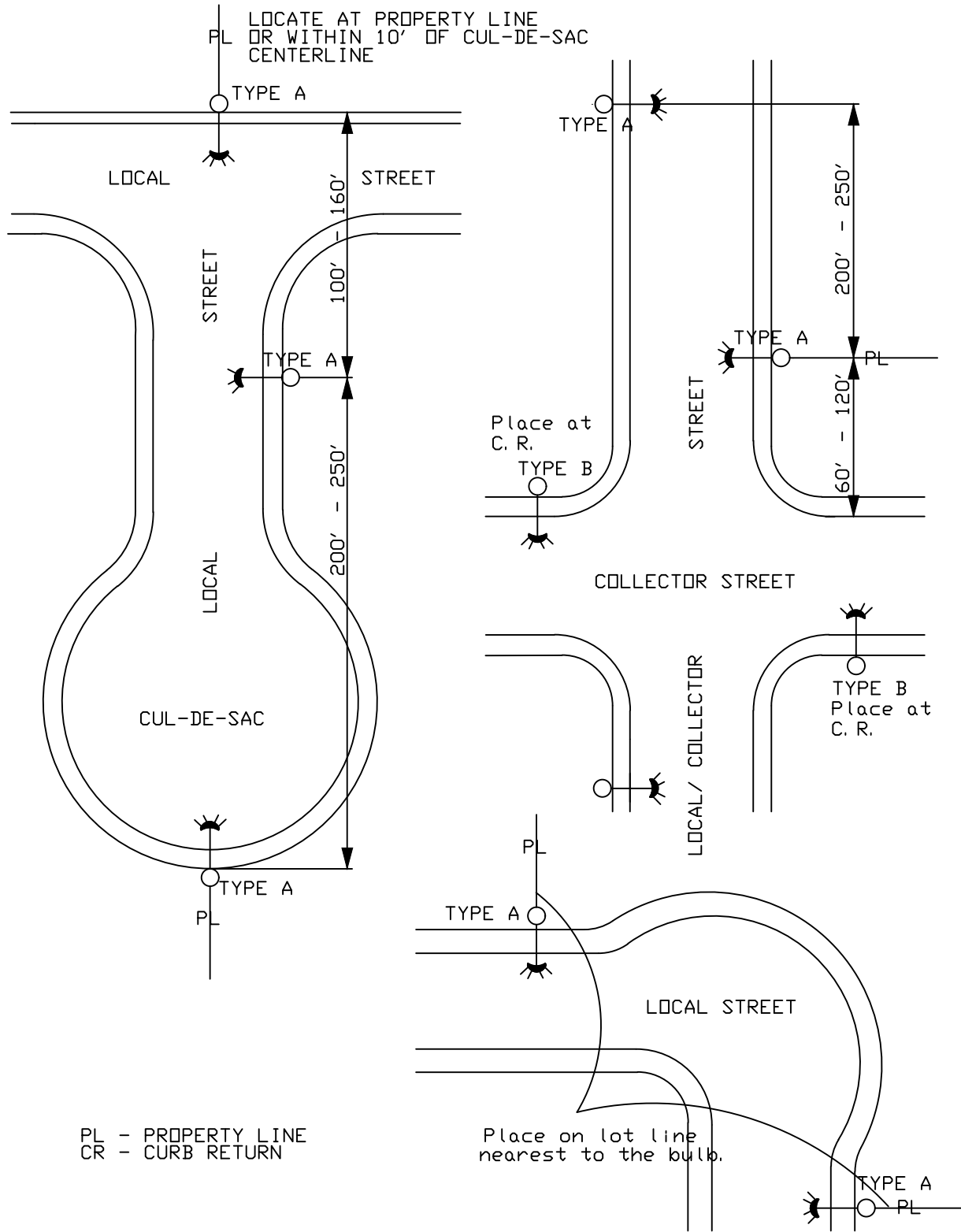

FIG.
7-1A

**STREET LIGHT LOCATIONS
LOCAL STREETS**



Approved: March 2022

CITY OF DIXON
ENGINEERING
DESIGN STANDARD



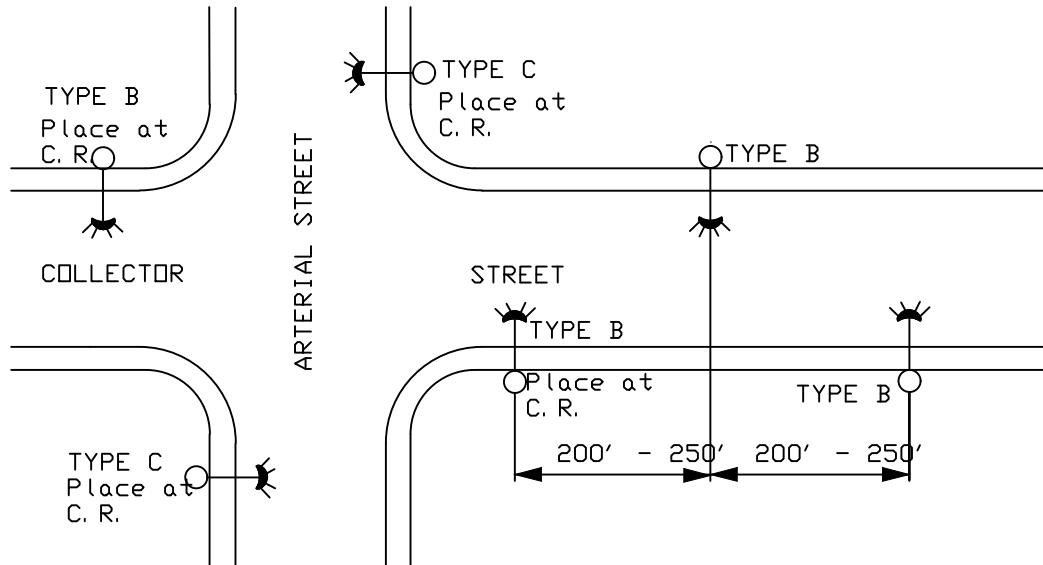

CR - CURB RETURN

NOTE:

1. Locate street lights on traffic signal poles at signalized intersections.



CITY OF DIXON
ENGINEERING
DESIGN STANDARD



Approved: March 2022

STREET LIGHT LOCATIONS
COLLECTOR STREETS

FIG.
7-1B

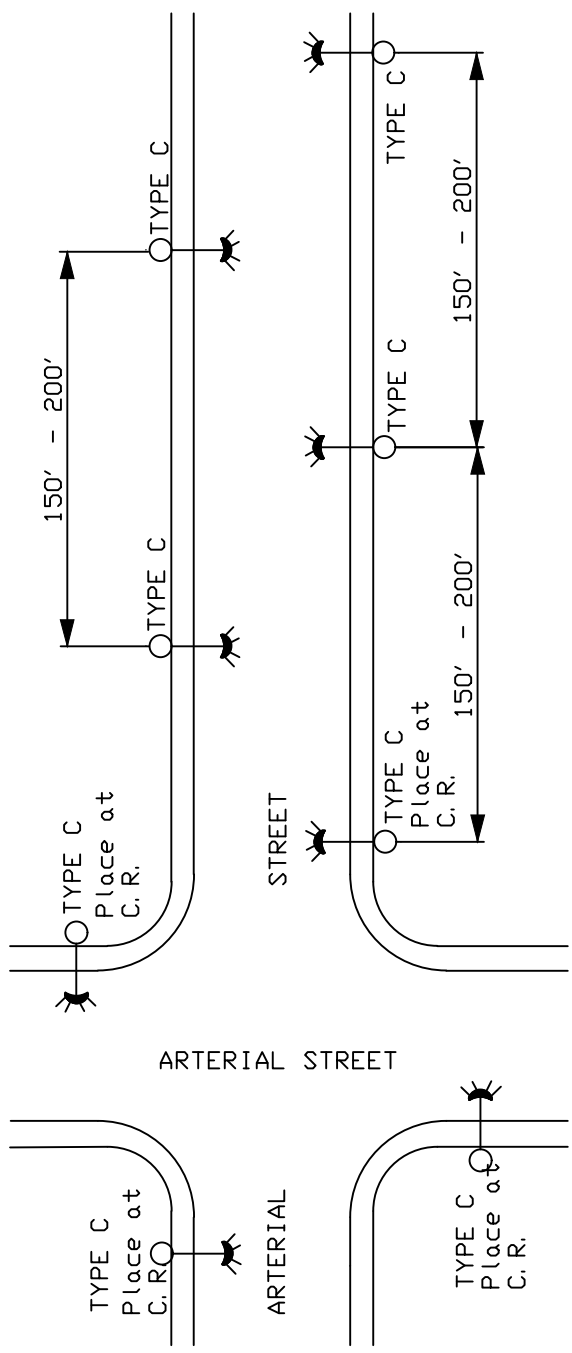

CR - CURB RETURN

- NOTE:
1. Locate street lights on traffic signal poles at signalized intersections.

FIG.
7-1C

STREET LIGHT LOCATIONS
ARTERIAL STREETS



CITY OF DIXON
ENGINEERING
DESIGN STANDARD

This Page Intentionally
Left Blank

ENGINEERING DESIGN STANDARDS

SECTION 8 – TRAFFIC SIGNAL DESIGN

DS8-01. GENERAL: The need for traffic signals shall be based on warrants contained in the Caltrans Traffic Manual. For a more detailed needs assessment, refer to DS15-07 “Study Methods and Techniques,” of these design standards.

Traffic signals shall be designed in accordance with these Standard Specifications and the latest editions of the following:

- Caltrans Standard Specifications and Standard Plans, including all standard symbols contained therein; and
- Manual on Uniform Traffic Control Devices with California Supplement.

DS8-02. SIGNAL STANDARDS: Traffic signal standards, posts and mast arms shall be of the types listed in the most recent edition of the State Standard Plans.

DS8-03. VEHICLE AND PEDESTRIAN SIGNALS:

All vehicle signals and pedestrian signals shall have terminal block components and be of the types listed in the most recent edition of the State Standard Plans.

All mast arm mounted vehicle signals shall be 12” in diameter and mast arm side-mounted (MAS).

Protected left turn signals shall be red, yellow and green all ways. All vehicle and pedestrian signals shall be LED type.

Programmed visibility vehicle signals shall not be used without prior approval of the City Engineer.

DS8-04. VEHICLE SIGNAL ALIGNMENT: Typical vehicle signal alignments are listed below. Case-by-case variations may occur.

1. For single lane left turns with protected left turn movement, the left turn signal shall line up with the center of the left turn lane as close as possible.
2. For two-lane left turns which shall have a protected movement, the left turn signal shall line up with the extension of the line between the two left turn lanes as close as possible.
3. When a protected left turn signal is used, the signal for the thru movement shall line up with the center of the thru lane group as close as possible, regardless of the number of thru lanes.
When 50 foot or 55 foot mast arms are used, only one MAS signal shall be used for the thru movement instead of two signals as shown in the State Standard Plans.
4. For one thru lane with permissive left turn without a left turn pocket, the MAS signal shall line up with the center of the left half (upon approach) of the thru lane, as close as possible. If a left turn pocket is provided, the MAS signal shall line up with the stripe between the thru and left turn lanes.

5. For two thru lanes with permissive left turn without a left turn pocket, the MAS signal shall line up with the center of the #1 thru lane (i.e., the lane adjacent to the left turn lane), as close as possible.
6. When a 4 section MAS signal is used, it shall line up with the center of the left half (upon approach) of the #1 thru lane, as close as possible.

DS8-05. NUMBER AND SIZE OF SIGNAL INDICATIONS: Typical indications are as follows:

1. Protected Left Turn Movements: One 3-section all arrow mast arm top-mounted (MAT) and one 3-section all arrow far left side pole mounted signal.
2. Thru Movements (with protected left turns): One 3-section MAS, one 3-section far right side pole mounted signal, and one 3 section near right side pole mounted signal.
3. Permissive Left Turn Movements: One 3-section MAS, one 3-section far left side pole mounted signal, one 3-section far right side pole mounted signal, and one 3-section near right side pole mounted signal.
4. Split Phasing: One 4-section MAS (w/green arrow), one 4-section far left side pole mounted signal (w/green arrow), one 3-section far right side pole mounted signal, and one 3-section near right side pole mounted signal.
5. Right Turn Overlap: Same as above except the far right side and near right side pole mounted signals shall be 5-section with green and yellow arrows. Overlaps require prohibited U-turn on associated protected left movements. Right turn arrow overlaps shall not be provided without prior approval of the City Engineer.

DS8-06. VEHICLE DETECTION FOR A MODULAR (MULTI OR SINGLE CAMERA) VIDEO DETECTION SYSTEM WITH OPTIONAL HIGH SPEED APPROACH RADAR/VIDEO FUSION TECHNOLOGY.

1. General: This specification sets forth the minimum requirements for a system that detects vehicles on a roadway using only video images of vehicle traffic.
2. System Hardware: The video detection system (VDS) shall consist of up to four video cameras, a video detection processor (VDP) capable of processing from one to four video sources, output extension modules, video surge suppressors and an industry standard 3-button USB mouse.
3. System Software: The system shall include software that detects vehicles in multiple lanes using only the video image. Detection zones shall be defined using only an on-board video menu and a pointing device to place the zones on a video image. Up to 24 detection zones per camera view shall be available. A separate computer shall not be required to program detection zones.

DS8-07. CONDUIT: Conduit requirements shall conform to the following (unless restricted by push button post size):

1. Service run conduit shall be 2-1/2 inch minimum diameter.
2. Conduit from the main pull box to the controller shall be two 3-inch diameter conduits minimum.

3. All signal runs and interconnect conduit shall be 2-inch minimum diameter.
4. All street crossing conduit runs shall be a minimum of 3 inches.

DS8-08. CONDUCTORS: All conductor runs for each signal phase to each terminal block on a pole shall be direct from the controller home run pull box. The conductor schedule shall not allow for splicing at intermediate pull box location.

DS8-09. PULL BOXES: Refer to Caltrans Standard Plans No. ES-8.

1. The minimum size for pull boxes shall be #5. However, #6 boxes shall be used at the ends of street crossings and when four or more conduits enter the box. Covers shall be concrete and marked “Traffic Signal.”
2. Larger pull boxes shall be required as follows:

Condition	Size
Any pull box with 12 or more cross section inches of conduit entering.	A pull box extension or 20” x 42” dual lid pull box.
Home run pull box for a 2, 3 or 5 phase signal.	20” x 42” dual lid pull box.
Home run pull box for an 8 phase signal.	30” x 48” dual lid pull box.

3. Traffic signal interconnect conduit shall be installed in separate concrete pull boxes and their covers shall be marked “Interconnect.”
4. Pull boxes subjected to vehicular traffic shall be installed with 1/4” steel plate traffic rated covers (galvanized after fabrication) with a diamond-plate type surface in accordance with ES-8 of the State Standard Plans.
5. Maximum spacing between pull boxes shall be 175 feet.

DS8-10. CONTROLLER CABINET LOCATION: Controller cabinet locations shall be approved by the City. Typical location should be on the minor street adjacent to the service pedestal. Both controller and service pedestal should be located such that the conduit from the service point to the service pedestal does not require trenching across a street. The controller cabinet door should be oriented so that the technician can view the entire intersection when standing at the front door.

DS8-11. PROTECTED VS. PERMISSIVE LEFT TURN PHASING: Protected left turn phasing should be provided under any of the following conditions:

1. For an intersection with one thru lane and a left turn pocket, a protected left turn may be required at the discretion of the City Engineer if the product of the left turn volume and conflicting volume exceeds 30,000 for any 1 hour.
2. Where any of the guidelines for protected left turns are met as outlined in the Manual on Uniform Traffic Control Devices with California Supplement.
3. Where there are two or more opposing thru lanes and the left turning vehicle occupies a dedicated left turn pocket, or where two-lane left turns are provided.
4. Where the travel distance through the intersection for left turn vehicles is more than 100 feet, and the 85th percentile speed of opposing traffic is 45 mph or more.

5. Where there are three or more opposing thru lanes.
6. Where the left turn queue recurrently occupies the #1 thru lane, and where two-lane left turn lanes cannot be provided, and where the left turn lane cannot be extended.

DS8-12. TRAFFIC SIGNAL INTERCONNECT: Traffic signal interconnect shall be provided for new signal installations, and for modification of existing signals, which currently do not have interconnect. The interconnect cable shall not share conduit with service conductors, but may share conduit with signal conductors and detector lead-in cables.

Interconnect conduit shall be installed half the distance to the next proposed signalized intersection, as determined by the City Engineer, and shall connect to existing interconnect conduit. If the installation of interconnect conduit completes the link between two signal, the interconnect cable shall be installed, wired to the terminal blocks and the signals shall be coordinated, as directed by the City Engineer.

Where interconnect conduit is installed and interconnect cable is not provided or required, a pull rope shall be installed in the conduit.

DS8-13. TRAFFIC CONTROL SIGNS: Pertinent traffic signs shall be specified with the signal design. Typical signs include mast arm mounted street name signs, R-73 mast arm mounted signs, R34-2 mast arm mounted signs, R49 signs (where crossing the street is permitted at only one location via crosswalk), R96 signs (where crossing the street is completely prohibited), W41 roadside signs (and pavement markings) where visibility of the signal is limited or where the signal may be unexpected by motorists, and R6 1 roadside signs on the geometric minor leg approach of a “tee” intersection.

In the case of R73 mast arm mounted signs, U-turns will only be permitted where there is at least 36 feet between the right side of the left turning vehicle and the curb to the far left of the vehicle.

Mast arm mounted street name signs shall be required for all approaches. These signs shall have a minimum lettering size of 8” U.C. and 6” L.C. with Type D stroke. Other lettering sizes shall require approval of the City Engineer. The signs shall be double sided. The signs shall have a visual reflectivity equal to V.I.P. diamond grade. Signs shall be installed using illuminated street name sign brackets in accordance with State Standard Plan ES-70. Street name signs shall be illuminated when directed by the City Engineer.

DS8-14. EMERGENCY VEHICLE PREEMPTION (EVP): All new traffic signals shall have EVP for all directions of approach on public streets. Each direction shall have a separate detector. Detectors shall be optical in nature and 3M Opticom equipment or approved equal.

DS8-15. SIGNAL PHASING: The phases shall be assigned with Phase 2 for northbound and Phase 8 for westbound.

DS8-16. ADVANCE FLASHING BEACONS: Advance flashing beacons shall be included at the discretion of the City Engineer. Typically they are located on roadways with speed limits 45 m.p.h. or greater when there are no controlled intersections within 1 mile.

DS8-17. MISCELLANEOUS APPURTENANCES:

1. Bicycle loops shall be installed for all approaches with bike lanes.
2. Audible pedestrian signals shall be required in all commercial areas and other areas as directed by the City Engineer.
3. Walking man (international symbol) type plate shall be used for all pedestrian push buttons and shall have black lettering on yellow background. Additionally pedestrian push button assembly shall be ADA compliant when constructed.
4. Additional pedestrian push buttons on medians of four or more lane roads may be considered where the center median/ pedestrian refuge area is a minimum of 10 feet in width with approval of City Engineer.
5. Push buttons shall be large button Americans with Disabilities Act (ADA) type and shall be submitted to City for approval.

DS8-18. PREPARATION OF PLANS: Traffic signal plan sheets shall conform to the provisions of Section 2, "Construction Plans Preparation, Submittal, and Processing," of these design standards, including submittal requirements, AutoCAD files, etc. Traffic signal plans shall have a title sheet followed by a signal and lighting sheet for each intersection. Signing, striping, and interconnect information may be included on the signal and lighting sheet, or may be included on separate sheets, depending on ease of readability.

1. Title Sheet: The title sheet shall include the following:
 - Title of project, which shall include location.
 - Vicinity map with north arrow, scale not required.
 - Pertinent signature blocks, and revision block.
 - Legend.
 - Service equipment schedule and wiring diagram with legend.
 - General Notes and the following Traffic Signal Notes
 1. All work shall conform to City of Dixon and Caltrans standards and specifications.
 2. No lane closures are permitted between the hours of 3:30 pm. and 9:00 am. Traffic control shall be per Caltrans Traffic Manual of Traffic Controls for Construction and Maintenance Work Zones.
 3. The Contractor shall be responsible for verification of all existing underground utilities, whether or not they are shown on these plans. The Contractor shall contact U.S.A. and have utilities marked at least 48 hours prior to beginning work. Where markings are near proposed foundations, the Contractor shall locate underground utilities by pot holing prior to excavating.
 4. Locations of signal standards, controller, and service pedestal as shown on these plans are approximate. Actual location shall be performed by the City Engineer in the field.
 5. The Contractor shall provide and install all equipment and materials necessary for the signal to operate as shown in the phase diagram.

2. Signals and Lighting Sheet: The signals and lighting sheet shall be drawn at a scale of 1 inch equals 20 feet, and shall include the following:
 - North arrow.
 - Existing and proposed field conditions such as: underground and overhead utilities; driveways; fire hydrants; poles; signs; fences; street lights; edge of pavement; curb, gutter and sidewalk; right-of-way; easements; striping; medians; pull boxes; curb ramps; trees; adjacent topography; etc. Existing conditions and appurtenances shall be dashed and screened. Proposed shall be solid and bold.
 - Pole and equipment schedule.
 - Conductor and conduit schedule. The schedule shall include percent fill conduit quantity and size.
 - Signalization appurtenances such as: conduit runs; detector loops with input designations; detector handholes; vehicle and pedestrian signals with phase designation; luminaries; pedestrian pushbuttons with phase designation; controller; service pedestal; service point; emergency vehicle detectors; signing; striping; and interconnect.
 - Phasing diagram.
 - Phasing for emergency vehicle preemption. Protected left turns shall be combined with the concurrent thru movement during EV preemption.
 - Conduit shall not pass through detector loops.
3. Utility Relocation Plan (as required): Show all existing and proposed underground and overhead utilities.
4. Striping and Signing Plan (20 or 40 scale): Shall include all existing signs, curb and pavement markings, and shall show disposition of each (removal, relocate, or remain). Shall show all necessary parking removal signs and curb markings.
5. Signal Interconnect Plan (as required.).
6. Civil Plan (20 or 40 scale): To include all paving, structural section, concrete, drainage, sanitary sewer, and earthwork items.
7. Signal Hardware:

Draft special provisions shall be submitted to the City for approval.

Service Pedestal: Type III-AF.

Cabinet: Type 332 Anodized aluminum, with 210 conflict monitor.

Controller: Type 1 70E with 68HC11 Chip with Comm port on front panel.

Prom Board: 412-F System Memory module with 27C1001 EPROM and full complement of RAM.

Software: Bitrans Systems program #233.

Detector Cards: Model 222 Caltrans approved.

Modem: Model 400.

LED Signal Heads: LED signal heads required for all new vehicular and pedestrian signal indications.

ENGINEERING DESIGN STANDARDS

SECTION 9 – SIGNING AND STRIPING DESIGN

DS9-01. SIGNING AND STRIPING: Existing and proposed signing and striping shall be designed in accordance with the latest edition of Manual on Uniform Traffic Control Devices with California Supplement, and this section of the City Standards. The Design Engineer shall be responsible for evaluating the adequacy and design of the existing signing and striping within and adjoining the project area as it relates to the proposed improvements.

The signing and striping shall be shown on a separate plan sheet and shall include the following notes and requirements:

1. All striping, pavement marking, and signing shall conform to the Design and Construction Standards of the City of Dixon as well as latest edition of Manual on Uniform Traffic Control Devices with California Supplement.
2. The Contractor shall notify the City Engineer a minimum of 2 working days to the day of layout of the proposed signing and striping.
3. The Contractor shall be responsible for layout and cat-tracking of all proposed striping and markings. Cat-tracking shall be done a minimum of 2 working days prior to proposed striping and marking to allow the City time for review and approval. No pavement striping and/or markings will be permitted until the cat-tracking has been approved.
4. All existing striping and pavement marking in conflict with proposed striping and markings shall be removed by grinding by the Contractor. Grinding methods shall be approved by the City Engineer. All legends where grinding is approved shall be ground into block shapes and sealed with one coat of asphalt sealer. All thermoplastic grindings shall be disposed at approved class waste disposal site.
5. Proposed striping and marking shall be installed the same day as the removal of the conflicting striping and marking.
6. All striping to include: pavement legends, crosswalks; and solid white lines; centerlines; and dashed lines shall be thermoplastic materials with reflectorized pavement markers, as needed per Caltrans standards.
7. All signing (warning, stop, etc.) shall be installed on two-inch galvanized metal poles per detail 3220, 3230 and 3240. If signs are installed on a street light pole, do not cover pole numbers.
8. Signs shall typically be installed behind the sidewalk area and on light poles wherever possible. The City Engineer may require signs to be placed in the sidewalk.
9. All signing shall be high-intensity with graffiti film (See Construction Detail 3220).
10. The plans shall show the Caltrans sign designation code and the location of installation with adequate dimensions.
11. Construction signs shall be installed per Caltrans standards.

This Page Intentionally
Left Blank

ENGINEERING DESIGN STANDARDS

SECTION 10 – MASONRY WALL DESIGN

DSI0-01. LOCATION REQUIREMENTS: When a masonry wall is required by the conditions of development for a project, the wall shall be placed on private property, with the face of the wall on the right-of-way line. Consideration shall be given in the placement of the masonry wall to the following:

- A. Masonry walls shall be placed so as to maintain appropriate sight distances from intersections. Wall heights may be stepped down to maintain sight distances. All masonry walls within 150 feet of an intersection shall require the approval of the City Engineer.
- B. Appropriate clearances must be maintained between the wall and all utilities.

DSI0-02. TYPE: The color and architectural treatment of the wall shall be approved by the Planning Commission and shown on the plans.

DSI0-03. DESIGN: All calculations for the wall shall be submitted to the Chief Building Official for approval.

All design details for the walls shall be shown on the improvement plans. Construction details shall include, at a minimum, the height, depth, spacing, footings, steel sizes and quantities for the wall.

DSI0-04. DETAILS: All pertinent details of the masonry wall design shall be shown on the plans. Such details shall include, but shall not be limited to, footing or pier depth and spacing, post spacing, wall height, amount and location of reinforcing steel, etc. When the City of Dixon is to maintain any part of a masonry wall, plans shall include the following note:

“The Contractor shall provide the City of Dixon City Engineer with the appropriate paint code or other information that may be necessary to maintain the masonry wall.”

This Page Intentionally
Left Blank

ENGINEERING DESIGN STANDARDS

SECTION 11 – SURVEY MONUMENTS

DS11-01. SUBDIVISION BOUNDARY: The boundary survey and final map shall be prepared by a licensed land surveyor or a registered civil engineer who is authorized to practice land surveying, who shall find or set a durable monument at each corner, angle point, or point of tangent of-curve, in the exterior boundary of the tract. The exterior boundary of the tract shall be monumented before the final map may be recorded.

"Durable monument" shall be one of the following:

1. An iron pipe not less than 2 inches in outside diameter, not less than 24 inches in length, set not less than 24 inches in the ground, and with a concrete (mortar) plug not less than 6 inches in length poured and tamped in the top of the pipe. A galvanized metal nail shall be set in top of the plug.
2. A lead plug not less than 3/4 inch in length and not less than 1/4 inch in diameter, set in a hole drilled in Portland cement concrete. A metal (galvanized) tack shall be set in top of the plug. Brass caps set in a concrete base will be acceptable.

The registered license number of the engineer or surveyor shall be permanently indicated on the monument.

DS11-02. INTERIOR PROPERTY LINES: All lot corners and angle points within the boundary of the subdivision shall be marked by 5/8 inch rebar, 24 inches long or by other approved methods. Crosses or ramset nails shall be set in the concrete on a 24" projection of each lot line.

DS11-03. STREET MONUMENTS: In general, street monuments shall be located at each angle point; at each point of beginning and end of a curve or at the point of intersection of the semi-tangents of curves (if accessible); at each point of intersection with the centerline of an existing boundary line, street, or alley; and at the point of intersection with the centerline of another street or alley. Unless conflicts occur with existing utilities, street monuments shall be set on centerline. All monuments shall conform to Construction Detail 3210 and be located at all points shown on the final map.

DS11-04. MONUMENT PROTECTION: The Design Engineer shall place a note on all construction plans stating that:

1. The Contractor is responsible for the protection of all existing monuments and other survey markers.
2. No final acceptance of the construction shall be issued until the survey monuments are in place.

DS11-05. VERTICAL CONTROL BENCHMARK: NAVD (North America Vertical Datum (1988)) shall be incorporated into each subdivision boundary survey monuments. The location and quantity of NAVD (North America Vertical Datum (1988)) benchmarks shall be proposed by the Design Engineer and approved by the City Engineer.

This Page Intentionally
Left Blank

ENGINEERING DESIGN STANDARDS

SECTION 12 – SUBDIVISION & DEVELOPMENT GRADING PLANS

DS12-01. GRADING PLAN: A Grading Plan shall be included in the improvement plans for subdivisions and other developments, when necessary. Guidelines for the preparation of the Grading Plan are as follows:

1. Grading plans shall be prepared by a registered Civil Engineer or licensed Architect in accordance with Appendix Chapter 33 of the California Build Code (CBC) and the Project Soils Report. The Grading Plan must comply with the City's Flood Ordinance.
2. Grading plans may require the signature of the Soils Engineer at the discretion of the City Engineer.
3. The Grading Plan will be on sheets of the same quality and size as the improvement plans.
4. The Grading Plan shall be the same scale as the improvement plans.
5. The plan shall clearly show each lot number, how each lot drains, and the pad elevation of each lot.
6. With the exception of hillside areas, each lot must drain to the street, without crossing the property line of any other lot.
7. There shall be no slopes steeper than 5:1 between the back of walk and the right-of-way line. Level areas having a minimum width of 2 feet shall be required at the toe and top of said slope. Maximum residential lot grades shall not exceed 8 percent (+/-8 percent) at the back edge of walk. See construction detail 3000, 3010, 3020 and 3030.
8. Drainage from hillside areas must be picked up in a ditch or swale at the right-of-way line of adjacent properties or in an easement from the adjacent property owner, rather than spilling over the sidewalk.
9. Grading plans shall include an Engineer's/Architect's Certification signature block confirming lot pads are graded within 0.2 feet plus or minus of the elevations shown on the approved plans. A separate Engineer's Certification signature block shall be included, as necessary, confirming lot pads compaction in accordance with Soils Engineer's recommendations; however, both certifications shall be required with record drawings.
10. Every part of the subdivision must be designed with a drainage release. The drainage release will be such that if any portion of the storm drain system fails, water will stand in the street no more than 1 foot deep and no less than 1 foot below the pad elevation of any house.
11. The plan shall clearly show (by contours, elevations, typical cross sections, etc.) the relationship of the Grading Plan to the existing ground and drainage pattern of adjacent properties.
12. Existing drainage patterns on adjacent properties must remain the same (or be improved) by the Grading Plan for the subdivision.
13. If retaining walls are needed, they shall be constructed of concrete or reinforced masonry block.
14. The plan shall show all drainage facilities being installed, clearly labeling high and low points and curb elevations.

DS12-02. GRADING AT TREES: Grading under trees with aesthetic value (oak trees and trees with a 9-inch diameter or larger, measured 4-1/2 feet above the ground, in healthy condition) shall be given special attention. Every reasonable effort shall be made to avoid removing trees or creating conditions adverse to the tree's health. The natural ground within the dripline of trees, especially oak

trees, shall remain as undisturbed as possible. Grading within the dripline of oak trees will not be permitted without adequate justification and approval by the City Engineer.

Cross sections may be required where trees are located adjacent to roadways, new slopes or critical areas. In addition, a dimension from the face of a tree to some critical point or line may be required.

The following comments regarding oak trees shall be included on all improvement plans where oak trees are to be saved:

1. Only those oak trees marked with an "X" are to be removed during construction.
2. During construction there shall be no grading, trenching, earth removal or addition, building pad formation or earth alteration of any kind within the dripline of any oak tree not marked with an "X."
3. During the construction phase of the project, a physical barricade shall be erected and maintained coincidental to the driplines of all oak trees not marked with an "X." Within this barrier no construction related activities shall be allowed including but not limited to vehicular parking or material storage.
4. The physical barricade shall be T-bars and 4 foot high hogwire fencing.

DS12-03. CONFIRMING PAD ELEVATIONS: Upon completion of the grading and prior to acceptance of the subdivision improvements by the City, the Design Engineer shall verify the final pad elevations. The elevations shall be verified at the center and the corners of each pad. Elevation deviations or more than 0.20 feet shall be noted on the tracings.

A signature block, confirming that final graded elevations in the field are the same as those shown on the plans, shall be included on the mylars of the subdivision grading plans. The Project Designer shall sign the signature block, confirming the pad elevation. The Design Engineer shall provide one set of signed as-built record grading plans in accordance with section DS2-04(E) of these standards.

DS12-04. GRADING PERMIT: A grading permit may be obtained to permit the Contractor to begin rough grading prior to approval of the improvement plans upon approval of the Grading Plan. No underground utility work can begin until the improvement plans are approved by the City Engineer.

DS12-05. EROSION AND SEDIMENTATION CONTROL PLANS:

1. **PLAN:** An erosion control and sedimentation control plan must be done for all projects. The plan shall follow the guidelines of the Stormwater Pollution Prevention Plan (SWPPP). The plan shall include site maps(s), and identification of construction/contractor activities describing measures for providing erosion and sediment control. The SWPPP shall be submitted with the first improvement plan submittal and implemented before construction start.
If the erosion control measures can be adequately described by reference to City Standard Details, a separate plan sheet need not be done. Reference to these Standard Details and Erosion Control Notes can be placed on the Grading Plan. If, however, in the opinion of the City Engineer, locations or details of erosion control appurtenances cannot be adequately described in notes, a separate Erosion Control Plan must be prepared. The Design Engineer shall consult the City Engineer regarding the need for a separate Erosion Control Plan prior to commencing preparation of project plans.
2. **EROSION CONTROL NOTES:** Notes shall be placed on the Erosion Control Plan (or on the Grading Plan if no separate Erosion Control Plan). See Erosion and Sedimentation Control Plan Notes page DS2.21 for additional information.

ENGINEERING DESIGN STANDARDS

SECTION 13 – IRRIGATION AND LANDSCAPING DESIGN

DS13-01. GENERAL: Design of all Public Landscaping Improvements within the City of Dixon shall be performed by a Licensed California Professional Landscape Architect or other Licensed Professional in accordance with these standards and criteria. Landscape improvement plans shall be prepared and submitted to the City for approval on plan sheets per City design standards DS2-03, “Preparation of Improvement Plans.” Prepared plans shall consist of title sheet, Irrigation plan sheet(s), Planting/grading plan sheet(s), construction details and notes. At conclusion of the project and prior to acceptance, the Landscape Architect shall provide the City as-built mylar plans of the completed project.

DS13-02. TITLE SHEET: The title sheet shall be prepared according to Figure 2-3 with the addition of a Designers Substantial Completion Block with the following statement:

“I hereby state that all improvements have been substantially constructed as represented on these plans.”

DS13-03. CONSTRUCTION PLANTING & GRADING PLANS: It is the intent of these design standards to permit the Landscape Architect when designing Public Landscape Improvements to incorporate individual expression with a desired theme, from park to park and subdivision streetscape to subdivision streetscape. It shall be the Landscape Architect’s task to apply City standard specifications, applicable City Ordinances including the Landscape Ordinance and industry standards into consideration as appropriate for his/her respective project assignment. Upon designing improvement plans, site features such as adjacent streets, curbs, walks lights, benches etc. shall be clearly shown on the construction planting plan and when incorporated into the project shall follow City of Dixon Standard Details and Specifications. Site drainage features shall be clearly incorporated into all Landscape planting plan(s). Additionally known underground utilities shall be noted on the irrigation plan(s). Upon completion of improvement plans, the City shall plan check and return comments to the Architect for revisions as outlined in DS2-05. The designer’s attention is directed to DS12-01 (7) regarding grade leveling minimum slope requirements in areas adjacent to sidewalk.

DS13-04. CONSTRUCTION NOTES: The following construction notes shall be incorporated into and utilized in all Public Landscaping Improvement plans.

GENERAL NOTES

1. Unless otherwise shown on these plans or noted in the special provisions, all work, materials and construction of Public Improvements shall conform to the City of Dixon Construction Specifications, Design Standards and/or latest edition of Caltrans Standard Plans and Specifications.
2. Approval of the City Engineer, or his authorized Representative, is required on completed work prior to (A) placing of concrete; (B) placing of aggregate base; (C) placing of asphalt concrete; (D) backfilling trenches. Work done without such approval shall be at the Contractor’s risk and subject to rejection by the City. Such approval shall not relieve the Contractor from the responsibility of performing the work in an acceptable manner.
3. The Contractor shall coordinate City inspections and submit required samples prior to commencing work for approval.

Required inspections shall include but are not necessarily limited to:

- a. Pre-Construction Meeting- grading, site conditions etc.
- b. Soil Preparation including application of weed killer, required amendments and pre-emergent herbicide
- c. Irrigation trenching layout
- d. Open trench hydrostatic pressure test for main line & lateral lines before backfilling trenches (Contractor shall center load piping providing all pipe joints and connections are exposed for the test):
 - i) Irrigation Mainline- The section(s) of the mainline shall be flushed of air, capped at ends and tested under full static line pressure for a minimum of 4 hours. Any leaks noted shall be repaired, defective materials replaced and re-tested. (At the Contractor's option a one hour pressure test at 100 PSI may be substituted for the above test, however the Contractor shall be responsible to provide pump and misc. equipment as may be necessary).
 - ii) Irrigation Laterals- All lateral lines shall be tested as specified above except that the test period shall be a minimum one (1) hour. Lateral pipes shall be plugged or capped at sprinklers, bubbler or drip connections and other locations necessary to perform the test.
- e. Irrigation operation and coverage
- f. Plant material
- g. Planting layout
- h. Pre-ninety day maintenance period final inspection
- i. Post-ninety day maintenance period final inspection

The following samples shall be submitted for approval prior to installation:

- a. Shredded bark mulch
 - b. Masonry block
 - c. Soil amendments, herbicides & weed killer
 - d. Other specialty item as determined by the City Engineer
4. Contractor shall be responsible for making him/herself familiar with construction site including all underground utilities, pipes and structures and shall take sole responsibility for all cost due to damages caused by his construction operations and subsequent replacement of said utilities and structures.
 5. Contractor shall not willfully proceed with construction as designed when it is obvious that unknown obstructions, area discrepancies and/or grade differences exist that may not have been known during design. Such conditions shall be immediately brought to the attention of the City Representative. The Contractor shall assume full responsibility for all necessary revisions due to failure to give such notification.
 6. Contractor shall be responsible for any coordination with subcontractors or utility agency as required to complete all construction items of work. All piping, conduit, sleeves, etc., shall be set in prior to installation of other construction items such as concrete or asphalt concrete pavement.
 7. All dimensions are from face of paving, walls, etc. unless otherwise noted.
 8. All property lines and lot lines shall be verified prior to commencing work.

9. Contractor is responsible to refer to coordinate grading with all improvement plans when such plans pertain to any aspect of his work items (e.g., grading, drainage structures, walls, footings, and other structures).
10. See Civil Engineer's Improvement plans, if applicable, for layout and construction of streets, drainage structures, parking lots, curbs and sidewalks and other civil improvements.
11. All gradients between spot elevations are assumed to be straight gradients.
12. Verify all station point locations in field, and report any discrepancies between station number shown and actual location of item to City Representative before proceeding with work.
13. All existing improvements, materials and plant material to remain within the new construction area shall be properly and adequately protected from damage. It shall be the responsibility of the Contractor to restore to original condition any existing item that is damaged or disturbed in any way.
14. All materials to be used or salvaged shall be stored in an area designated by the City or developer/owner for that purpose. All salvaged materials shall remain the property of the City or developer/owner.
15. All streets, sidewalks and adjacent properties shall be protected throughout construction operations.
16. Landscape maintenance period shall commence after acceptance of improvements by the Dixon City Council and shall continue for 90 calendar days. Maintenance items shall include watering, weeding, fertilizing, mowing, spraying, and pruning necessary to keep the plants in a healthy growing condition. At the end of the maintenance period, all plant materials shall be in healthy growing condition and landscape areas weed free and cleaned of all debris. At the direction of the City Engineer during the maintenance period, any plant exhibiting weakness, vandalized or displaying the probability of dying, shall be replaced immediately by the Contractor at his own expense.
17. Should any plant materials be diseased or other installed material prove defective or should the installation as a whole prove defective, due to faulty workmanship, materials furnished or methods of installation, or should the said improvement or any part thereof fail to live or function properly, as planned, due to any of the above causes, all within one year after acceptance of landscape improvements by the Dixon City Council, the Contractor agrees that repairs shall be made within fifteen (15) calendar days after receipt of written notice from the City.
18. The Contractor shall take appropriate measures to protect the public from all hazards created by his operations. All excavations & trenches over 12" in depth adjacent to public walkways, within parks etc. shall be barricaded from the public or as directed by the City Engineer.
19. The Contractor or any subcontractor shall notify members of USA 2 working days in advance of performing excavation work by calling the toll-free number 1-800-227-2600. Excavation is defined as being 18" or more in depth below the existing grade surface.

GRADING NOTES

1. All proposed grades shall be constructed to properly drain in accordance with approved grading plans. Grades are to meet or blend in with existing grading at project limits and existing walkways and sidewalks. Precise elevations indicated on plans to be verified in field to as-built condition.
2. The location of features to be constructed not specifically dimensioned may be determined by scale. If conflicts arise in field, contact City Representative for resolution.

3. If in the field, scaled dimensions conflict with stated grades, and/or elevations, the stated design elevations shall take precedence.
4. Contractor shall be responsible for "Rounding Off" all sharp ridges existing on site whether or not such conditions are indicated on plans.
5. Grade tolerances shall conform to the following approved schedule unless otherwise noted on the plans or in the special provisions:
 - a. Rough Grading - +/- 0.2 ft
 - b. Finish Grading - +/- 0.1 ft
 - c. All Paving - +/- 0.1 ft
 - d. All 85 & SD Pipe - +/- 0.1 ft
 - e. All Structures - +/- 0.1 ft

LANDSCAPING NOTES

1. Contractor shall field verify and accept existing site grading prior to commencement of work. Said work shall consist of installation of irrigation systems, soil preparation, planting, fertilizing and maintaining landscape plantings throughout construction activities and 90 day maintenance period. All planter beds shall receive a 3 inch thick layer of shredded bark mulch.
2. No planting shall occur during weather conditions which will adversely affect materials or when soil is in a muddy condition as determined by the Landscape Architect. Contractor shall not plant at the end of the day, on Fridays or before holidays unless a special crew has been assigned to care for plants on the next calendar day, and on weekends and holidays.
3. SOIL PREPARATION
 - a. In accordance with the Landscape Architect's recommendations, all imported soils shall be tested by a City approved soils laboratory.
 - b. The Contractor shall prepare all landscape areas by removing all weeds, debris, rubbish and 1" diameter or larger stones.
 - c. Planting areas shall be completely till cultivated with soilamendments recommended by the Landscape Architect, to a minimum depth of 12 inches. See planting details for additional information.
 - d. Subsequent to installation of irrigation system(s) and prior to installation of plant materials, the Contractor shall:
 - i) Restore plan grades by floating turf areas and planter beds to a smooth uniform grade and slope.
 - ii) Thoroughly water down beds, turf areas etc. and allow 7 days to pass before applying Ron-Star, Round-Up or other approved weed killing agent in accordance with manufacturer's recommendations.
 - e. Applied fertilizer shall be commercial grade inorganic in granular or pellet form. The Contractor shall follow Landscape Architect's recommendations for required fertilizer application. See planting details for additional information.
4. Prior to installation of mulch, a pre-emergent herbicide shall be applied to all planter beds in accordance to manufacturer's recommendations after plantings have been installed. As required by Landscape Architect, chemicals used are to be in written chemical weed control program prepared by a licensed pest control advisor and approved by the City. The

Contractor is responsible to possess and maintain all local agency permits or licenses necessary for application of herbicide chemicals.

5. PLANTING NOTES- Plant materials shall be planted in accordance with the following provisions and as directed by the City Engineer or his authorized Representative. Plant substitutions shall not be permitted unless previously recommended by the Landscape Architect and approved by the City Engineer. In all cases, the City shall give final approval of all substitutions.
 - a. Plants shall be delivered to site healthy, shapely, and well-rooted. Roots shall show no evidence of having been root bound, girdled, restricted or deformed. Plants shall have straight trunks with the leader intact, undamaged and uncut. All old abrasions and cuts shall be completely calloused over. All plants shall be measured when their branches are in their normal position. Height of plant is measured from the root crown to the top of the plant. Width of plant is measured at branching at the widest point. Indicated sizes shown are before pruning. Plants shall not be pruned prior to delivery except upon approval of the City Engineer.
 - b. Trees shall be shapely and well tapered from trunk base so that when the nursery stake is removed, the tree supports itself upright without further staking. Trees shall have a main leader, and the main branches shall be spaced vertically and alternately along the trunk. Branching shall not be concentrated in one location nor shall there be severe crossing of branches. Branches shall be smaller in diameter than the trunk, and at least one-half of the foliage on the branches shall be located along the lower two-thirds of the trunk.
 - c. Plant material shall be removed from the containers in such a manner that the root ball is not broken, and they shall be planted and watered as hereinafter specified immediately after their removal. Containers shall not be cut prior to delivery of plants to planting area. Root balls of plants temporarily removed from containers prior to planting shall be kept moist and covered at all times, and shall not be exposed to the air except while actually being placed in the ground.
 - d. No planting will be allowed until soil preparations have been completed and required amendments, herbicides and other quantities used have been inspected and verified by the City Representative. The City Representative may also inspect all plants prior to planting. Plants displaying root bound or girdled root characteristics shall be rejected and the Contractor shall remove such plants from work site at the end of the workday.
 - e. Shredded bark mulch shall not be installed until the City has verified application of pre-emergent herbicide and has approved of shredded bark mulch sample.
6. IRRIGATION NOTES- All irrigation parts and materials utilized throughout the system(s) shall be new and in perfect condition. Contractor should reference irrigation equipment parts except for piping, offsets & sleeves on the plan construction detail sheet of the construction plans. Irrigation design is diagrammatic unless otherwise noted; therefore piping shown within paved areas is for design clarification only. Such piping shall be installed in planting areas unless installed in pipe sleeves. Generally, irrigation mainline and laterals shall be installed adjacent to walkways, walls or other existing features as appropriate. Additionally, piping shall not be installed beneath trees or shrubbery. Under no circumstance shall irrigation piping be installed so that pipes come in contact with one another. All piping shall be installed so as to maintain a minimum 6 inch separation. The Contractor shall keep detailed notes of approximate locations of piping and incorporate into as-built construction plans.

- a. Generally due to scale of drawing, it is not possible to indicate all irrigation offsets, fittings, sleeves, etc. which may be required. Therefore, the Contractor shall be responsible to investigate site conditions affecting his work and plan accordingly.
- b. A licensed electrical Contractor shall supply power to controller, and irrigation Contractor shall be responsible to make final electrical connection when installing controller and valve wiring.
 - i) Each controller shall have its own independent groundwire.
 - ii) Splicing of 24 volt wires shall not be permitted except in valve boxes where there are 24 inch wire coils of excess wiring at each splice and 100 feet on-center along wire run. Tape excess wire in bundles 10 feet on-center except inside sleeves.
 - iii) Install a spare control wire (different color) along entire wiring run, and loop the same in 36 inch excess coil inside each single remote valve box and inside one of each group of valve boxes.
 - iv) Contractor shall install identification tag inside each remote valve box noting controller & remote valve number.
- c. The irrigation Contractor shall flush, clean and adjust irrigation heads for optimum performance and to prevent overspray onto walkways, roads, buildings etc. as necessary. This shall include selecting the best degree of arc to fit the existing site conditions and to throttle the flow control at each remote valve to obtain optimum operating pressure for each system. Additionally Contractor shall make minor adjustments to the system as may be necessary and shall report any required major adjustments to the City. The City shall either direct the Contractor as to corrective measures required or shall consult the irrigation designer regarding the deficiency.
- d. Irrigation boxes shall be installed approximately 12 inch from and perpendicular to walks, curbs etc. and a minimum of 12 inch separation shall be maintained between other remote valve boxes when grouped. Unless specified the short end of valve box shall be installed adjacent to walks, curbs etc. Each irrigation remote valve box shall house a single remote control valve.
- e. All existing surface and underground facilities damaged or cut as a result of the Contractor's operations shall be restored to original condition. Except as specified herein, excavating and trenching, backfill and compaction shall conform to City of Dixon Construction Details and Specifications for piping larger than 4 inches in diameter. Within landscaped areas, backfill and compaction of trenches housing piping 4 inches in diameter and less shall be as follows:
 - i) Backfill material shall be clean native fill free of stones, debris or other foreign materials.
 - ii) Trench compaction shall be maintained at 90 percent relative compaction (applies to all pipe sizes). Jetting of irrigation trenches may be approved by the City Inspector in landscaped areas which are not beneath sidewalks or other structures.
- f. Pipe, fittings and other irrigation components shall be assembled according to manufacturer's recommendations. Pipe, fittings etc. shall be thoroughly cleaned before applying primer and solvent. Connections between PVC pipe and metal valves or steel pipe with threaded fittings shall be made using plastic male adapters, and a non-hardening pipe dope (rector seal or Teflon tape) shall be applied to male threads. Unless otherwise specified, brass unions shall be installed on each side of all irrigation valves, backflow prevention equipment, filters and ball controlled shut off valves shall be installed upstream of all remote control valves.

The irrigation central control system shall be the Rain Master Irrigation Systems, Inc. When 6 or more remote valves are required, the controller shall be Evolution DX2 including flow sensor device (FSAY), Evolution communication hardware including radio and dome RDM and Promax remote control (PMR-CAC) receiver.

For systems requiring less than 6 remote valves, the controller shall be Rainmaster Eagle Controller including flow sensor & master valve (ESMV) and Promax receiver (PMR-CAC). There is no known equal to Rainmaster controller systems, submittals shall be required.

PLANTING LEGEND

The plans shall depict various planter beds and areas with plant material and landscape features in accordance with industry standard practices. The Landscape Architect (designer) shall responsible for landscape plant material conforming to the City of Dixon “Water Efficient Landscape Ordinance,” Ordinance No. 9212, adopted December 8, 1992, or the most currently adopted ordinance. All plans shall include as a minimum the following reference criteria:

Plant Symbol	Spacing	Quantity	Common Name	Botanical Name
--------------	---------	----------	-------------	----------------

WATER USAGE CONSUMPTION CHART

	Evapotranspiration Rates (inches)	Evapotranspiration Rates (feet)	Landscape Area (Sq.Ft.)	Total (Cu. Ft.)	Total (Gal.)
January	X	Y	Z	A	B
February	-----	-----	-----	-----	-----
March	-----	-----	-----	-----	-----
April	-----	-----	-----	-----	-----
May	-----	-----	-----	-----	-----
June	-----	-----	-----	-----	-----
July	-----	-----	-----	-----	-----
August	-----	-----	-----	-----	-----
September	-----	-----	-----	-----	-----
October	-----	-----	-----	-----	-----
November	-----	-----	-----	-----	-----
December	-----	-----	-----	-----	-----

Plans of planter beds and landscape areas shall clearly identify, depict, and quantify all plant materials. Areas to receive shredded bark mulch shall also be noted. Architect shall use City Landscaping Notes but may modify and/or append specifications as may be required.

DS13-05. IRRIGATION DESIGN: Irrigation systems shall be designed to include all appurtenances, incidentals and accessories required for proper installation and operation of the system(s). The Landscape Architect shall apply City of Dixon and as necessary industry standards when designing and depicting Public Improvement Irrigation Plans.

Architect shall clearly identify and detail required components of the system(s) including any specialty items such as booster pumps, drip irrigation components, fenced enclosures etc. Plans should show supply

water main line point of connection, water meters, back flow prevention, controllers, irrigation mains and laterals, irrigation heads, remote control valves, drip units, bubblers, filters, pumps etc., on the plans.

DS13-06. SPECIALTY SITE FEATURES: All specialty site features to be incorporated into the Landscape Improvement Plans shall be designed and depicted clearly on the plans. As with any specialty feature, lighting improvements, drainage items or other items specified within City Specifications shall be designed in accordance with City of Dixon Design and Construction Standards as applicable, unless otherwise directed by the City Engineer. Items such as block walls, misc. fencing, children's play equipment or other shall be designed according to industry standards and/or as directed by authorized City Engineer.

DS13-07. MEDIAN ISLAND LANDSCAPING: Median island landscaping design shall include installation of storm drainage systems consisting of area drain inlets and necessary piping along with landscape erosion protection measures. Maintenance turn-out may be required as determined by the City Engineer. See Standard Detail 3340.

ENGINEERING DESIGN STANDARDS

SECTION 14 – DEVELOPMENT SITE ACCESS

DS14-01. GENERAL: Driveways shall meet sight distance requirements as discussed in DS3-10 of these design standards for both ingressing and egressing movements. Driveway width, type, and design shall conform to DS3-15 of these design standards.

Backing of vehicles out of driveways onto the roadway shall only be permitted for single-family residential or duplex land uses. All other land uses shall be designed such that both ingressing and egressing vehicles are facing forward.

Driveways shall be oriented to provide at least 5 feet between the driveways traveled way and appurtenances such as fire hydrants, poles, and drop inlets.

The City recognizes that infill projects (projects within older, previously developed areas) may have certain constraints such as lot size, existing driveways near the property line on adjacent parcels, etc. which may deem it impractical to achieve the requirements contained in these design standards for site access. Infill projects such as these will be evaluated on a case-by-case basis by the City. However, the goal will be to achieve the requirements herein to the extent practical.

DS14-02. DRIVEWAY LOCATIONS AND SPACING:

Driveway Locations on Local Streets and Minor Collector Streets

- A. For single-family residential or duplex, the following standards shall apply:

Driveways shall be a minimum of 10 feet apart, measured from edge to edge, except in cul-de-sac bulbs and the outside portion of knuckles, where the minimum shall be 5 feet.

Where a local street intersects a local street or cul-de-sac, driveways shall be located at least 50 feet from the face of curb of the intersecting street.

Where a local street or minor collector street intersects a minor collector street, driveways shall be located at least 75 feet from the face of curb of the intersecting collector street to the centerline of the driveway and front the local street at local street corner lots. This may be accomplished by designing a local street parallel to the minor collector street providing access to the lots. Special consideration will be made in unusual circumstances.

- B. For land uses other than single-family residential or duplex fronting local streets or minor collector streets, the following standards shall apply:

Driveways shall be a minimum of 100 feet apart, measured between driveway centerlines, except on cul-de-sacs and knuckles where driveways shall be shared or otherwise designed to minimize the number of driveways to the extent possible. For corner parcels, driveways shall be located at least 100 feet from the face of curb of the intersecting street, measured from the centerline of the driveway. Where the local street or minor collector street

intersects a minor collector street, driveways shall be located at least 150 feet from the face of curb of the intersecting street, measure from the driveway centerline, and shall front the local street at local street corner lots.

Driveway Locations on Major Collector or Arterial Streets

There shall be no driveways along major collector or arterial streets serving single-family residential or duplex land uses. Driveways on the same side of the street shall be at least 200 feet apart, measured between driveway centerlines, on major collector streets and at least 250 feet apart, measured between driveway centerlines, on arterial streets. For major collector streets, driveways shall be at least 150 feet from the face of curb of the intersecting street. For minimum driveway distances from intersections on arterial streets, see Figure 14-1. For driveway spacing on opposite sides of the street (offset spacing), see Minimum Offset of Opposing Driveways.

Minimum Offset of Opposing Driveways

For land uses other than single-family residential or residential duplex, the centerline of driveways on opposite sides of the street shall either be in direct line, or have a minimum offset distance as listed below (measured from the centerline of the driveways):

- A. For driveways on local streets, the minimum centerline offset shall be 100 feet.
- B. For driveways on collectors, the minimum centerline offset shall be 200 feet.
- C. For driveways on arterials, offsets shall be considered on a case-by-case basis.

Where a raised median is provided along the center of the street separating conflicting turning movements, the offset requirements as stated above will not apply.

Number of Driveways Serving a Parcel or Site

For single-family residential or duplex land uses, only one driveway per parcel will be permitted. Where circular drives are proposed on a property, there shall be a minimum frontage of 150 feet and the circular drive must be approved by the City Engineer.

For other land uses, the number of driveways shall be minimized, but not to a point that could cause local congestion within the public right-of-way. Consolidation of driveways with adjacent parcels shall occur whenever possible. Where driveway location standards cannot be met for a parcel, the City may require the only access to that parcel be achieved via cross access over an adjacent parcel. This shall satisfy legal requirements for access to a parcel, and the City therefore shall not be required to permit direct access to any parcel via a driveway along the parcel's frontage.

Where land uses other than single-family residential or duplex are adjacent, the City typically requires cross access to minimize use of the public streets to travel between adjacent developments.

For projects requiring a traffic study (see Figure 15-1), the study shall evaluate the proposed site access for the project. The study shall discuss balancing the number of driveways for the project so the number of driveways and required throat depths are minimized, while providing a sufficient number of access points to minimize congestion and delay.

Right-Turn Deceleration/Acceleration Lanes for Driveways

A right-turn deceleration lane shall be provided for a driveway if all of the following conditions are met:

- A. The driveway is located on an arterial.
- B. Right-turn ingress volume is expected to exceed 50 peak hour vehicles on the arterial.
- C. There is ample right-of-way and frontage to provide a deceleration lane as determined by the City Engineer. Right-of-way dedication may be required.
- D. The 85th percentile travel speed of the roadway, as determined by the City Engineer, equals or exceeds 40 mph.

There may be cases where some of the above criteria are not met, but City Engineer may require a deceleration lane in the interest of safety.

There may be cases where it will be necessary to merge a deceleration lane with an existing acceleration lane. Where the beginning of a deceleration taper will be within 100 feet of the end of an acceleration taper, then the deceleration and acceleration shall be merged to form a continuous auxiliary lane.

There may be cases where it is desirable to provide room for right-turn deceleration, but an entirely separate deceleration lane is either too difficult to install, due to design constraints, or is not reasonable. In these cases, a right-turn curb taper shall be provided in accordance with Figure 14- 2.

Right-turn acceleration lanes for driveways shall not be provided.

Left-Turn Deceleration/Acceleration Lanes for Driveways

Left-turn deceleration lanes (left-turn pockets) are not typically required on minor collector or residential streets unless required by the City Engineer as a traffic calming measure.

On major collectors or arterials where left-turn ingress will be permitted, a left-turn deceleration lane shall be considered at the time of tentative map submittal or street improvements of existing intersections/mid-block locations if one or more of the following conditions are met:

1. Twenty-five or more vehicles make or are projected to make a left-turn and are in conflict with 100 or more vehicles on the through road during the peak hour and the 85th percentile speeds on the through road, as determined by the City Engineer, equals or exceeds 40 mph.
2. Four or more reported accidents which are susceptible for correction by a left-turn pocket installation have occurred during a 12-month period. Accident types include rear end and same direction sideswipes involving left-turning vehicles.
3. The visibility of approaching traffic is less than the safe stopping sight distance for the 85th percentile speed as listed in Table 201.1 of the California Department of Transportation Highway Design Manual.

Left-turn lanes may be in the form of a separate left-turn pocket or a continuous two-way, left-turn-lane. The minimum left-turn pocket length shall be 150 feet with a 90 foot entry taper. Longer left-turn pockets may be required if a traffic study demonstrates the need.

If a raised curb median island exists, all of the policy warrants for median openings must be met in accordance with DS14-05 "Median Openings," along with any one of the warrants for left-turn pockets.

The satisfaction of these warrants is not a guarantee that the left-turn pocket will be permitted. The warrants are strictly for consideration purposes only. The installation of the left-turn pocket must be compatible with the traffic safety and circulation of the area.

Separate left-turn acceleration lanes are not typically required.

Restricted Turning Movements for Driveways on Arterial Streets

Turning movement restrictions shall apply to unsignalized driveways on arterial streets per Figure 14-1.

DS14-03. DRIVEWAY MINIMUM REQUIRED THROAT DEPTHS: Driveways shall meet the minimum required throat depth (MRTD) requirements as discussed in DS15, "Traffic Impact Analysis." In the case of "drive-thru" facilities, attention is directed to the minimum on-site storage distances for ingressing vehicles.

On-site parking shall not be permitted within the MRTD area. The MRTD requirement does not apply to single-family residential or duplex land uses.

In cases where a traffic study is not required, or in cases where there is insufficient data available to calculate the MRTD in accordance with DS15, "Traffic Impact Analysis," Table 14-1 shall be used to determine minimum required throat depth for access points for a site. In cases where a traffic study will be provided, but the access points have not yet been determined for a site, Table 14-1 shall be used to estimate the MRTD during the site design process. In these cases, the final MRTD requirements shall be determined by the traffic study via the methodology in DS15. The distances shown in Table 14-1 chart represent vehicle storage equivalents, which means the total required distance may be achieved by summing the throat depths for several access points if more than one access point is to serve the site. In these cases, the distance shown in Table 14-1 shall be prorated to each access point to the nearest 25 feet based on the estimated relative percent usage of each access point.

DS14-04. SIGNALIZED DRIVEWAYS: The need for signalized driveways shall be based on warrants contained in the latest edition of the Caltrans Traffic Manual. Any such evaluation shall be performed by the consultant as part of the traffic study for the project in accordance with DS15, "Traffic Impact Analysis."

Attention is also directed to DS15, "Traffic Impact Analysis" for minimum required throat depth (MRTD) for signalized access locations.

The City does not share in the cost of design and construction of traffic signals at driveways required as a mitigation of development. The developer shall bear all costs of providing signalization at the private access point, including design and construction. This obligation is in addition to required Traffic Mitigation Fees. Maintenance and operation of these traffic signals shall be accepted by the City.

DS14-05. MID-BLOCK MEDIAN OPENINGS: Mid-block median openings to permit turns to and from adjacent property will not normally be considered unless all of the following conditions are met:

1. The property to be served has continuous frontage of 200 feet or more along the street.
2. The median opening is not less than 500 feet from an intersection, measured between the centerlines.
3. The median opening is not less than 500 feet from any other existing or proposed mid-block median opening, measured between the centerlines.

Those openings which are proposed with left-turn pockets must also satisfy one or more of the warrants listed in DS14-03. The satisfaction of these warrants is not a guarantee that the median opening will be allowed. These warrants are strictly for consideration purposes only. The opening must conform to the traffic safety and circulation of the area.

TABLE 14-1
MINIMUM THROAT DEPTH

Land Use	Size	Street Type		
		Local	Collector	Arterial
Apartments, Condos, Mobile Homes, Planned Unit Development	0 - 80 units	25'	50'	50'
	81 - 160 units	50'	50'	50'
	> 160 units	50'	50'	100'
Quality/ Sit Down Restaurant	0 - 15,000 SF	25'	25'	25'
	> 15,000 SF	25'	25'	50'
Drive-Thru Restaurant	0- 2000 SF	25'	25'	50'
	2001 - 3000 SF	25'	50'	100'
	3001 - 5000 SF	50'	75'	150'
	>5000 SF	75'	100'	225'
Motel]	0 - 150 rooms	25'	25'	50'
	151 - 400 rooms	25'	75'	100'
	>400 rooms	25'	125'	150'
Convention Hotel	0 - 150 rooms	50'	50'	100'
	151 - 400 rooms	50'	150'	250'
	>400rooms	50'	250'	350'
Office Park	0 - 20,000 SF	25'	25'	25'
	20,001 - 50,000 SF	25'	50'	75'
	50,001 - 100,000 SF	50'	75'	175'
	100,001 - 150,000 SF	75'	125'	250'
	150,001 - 300,000 SF	125'	250'	500'
	> 300,000 SF	150'	400'	825'
General Office	0 - 50,000 SF	25'	25'	50'
	50,001 - 100,000 SF	25'	50'	100'
	100,001 - 150,000 SF	50'	75'	175'
	150,001 - 200,000 SF	50'	100'	225'
	200,001 - 300,000 SF	75'	175'	350'
	300,001 - 400,000 SF	125'	225'	450'
	> 400,000 SF	150'	275'	575'
Light Industrial	0 - 100,000 SF	25'	25'	50'
	100,001 - 200,000 SF	25'	50'	100'
	200,001 - 300,000 SF	50'	75'	150'
	300,001 - 400,000 SF	50'	100'	200'
	> 400,000 SF	75'	12'	250'
Industrial Park	0 - 500,000 SF	25'	25'	50'
Discount Store	0 - 30,000 SF	25'	25'	25'
	30,001 - 50,000 SF	25'	50'	75'
	50,001 - 75,000 SF	25'	50'	125'
	>75 000 SF	50'	75'	175'

TABLE 14-1 (cont.)
MINIMUM THROAT DEPTH

Land Use	Size	Street Type		
		Local	Collector	Arterial
Shopping Center	0 - 10,000 SF	25'	25'	50'
	10,001 - 20,000 SF	25'	50'	125'
	20,001 - 30,000 SF	50'	100'	175'
	30,001 - 40,000 SF	75'	125'	225'
	40,001 - 100,000 SF	75'	150'	250'
	100,001 - 150,000 SF	100'	175'	375'
	150,001 - 200,000 SF	125'	250'	500'
	200,001 - 250,000 SF	150'	300'	625'
	250,001 - 600,000 SF	175'	375'	750'
	600,001 - 700,000 SF	200'	375'	750'
	700,001 - 800,000 SF	225'	425'	875'
	800,001 - 900,000 SF	250'	500'	975'
	900,001 - 1,000,000 SF	275'	550'	1075'
> 1,000,000 SF	425'	825'	1275'	
Drive-In Bank	0 - 10,000 SF	25'	25'	50'
	10,001 - 20,000 SF	50'	50'	150'
	20,001 - 30,000 SF	75'	150'	250'
	30,001 - 40,000 SF	100'	200'	350'
	>40,000 SF	150'	250'	450'
Supermarket	0 - 20,000 SF	25'	25'	50'
	20,001 - 30,000 SF	25'	50'	75'
	30,001 - 40,000 SF	25'	50'	100'
	>40,000 SF	25'	75'	150'
Medical Clinic	0 - 100 employees	25'	25'	50'

This Page Intentionally
Left Blank

FIGURE 14-1 PERMITTED DRIVEWAYS/ STREETS ON ARTERIALS

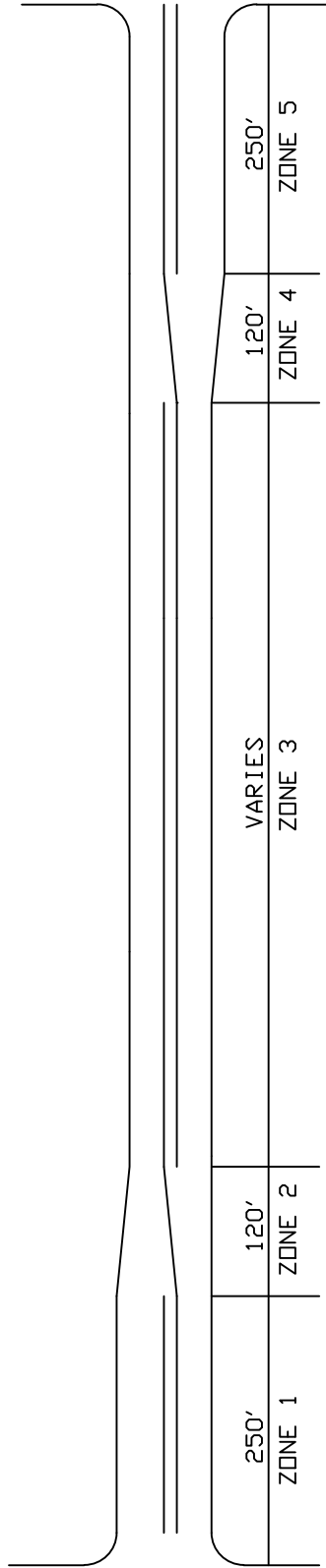

- ZONE 1- NO DRIVEWAYS OR STREETS ALLOWED.
- ZONE 2- DRIVEWAYS AND STREETS ALLOWED. LEFT-TURNS OUT PROHIBITED.
- ZONE 3- DRIVEWAYS AND STREETS ALLOWED. ALL TURNING MOVEMENTS PERMITTED.
- ZONE 4- DRIVEWAYS AND STREETS ALLOWED. LEFT-TURN IN AND OUT PROHIBITED.
- ZONE 5- NO DRIVEWAYS OR STREETS ALLOWED.

NOTE:

All spacing shall be measured from center of driveway to face of curb of intersecting street.



CITY OF DIXON
ENGINEERING
DESIGN STANDARD



Approved: March 2022

PERMITTED DRIVEWAYS/
STREETS ON ARTERIALS

FIG.
14-1

FIGURE 14-2 RIGHT-TURN CURB FLARE

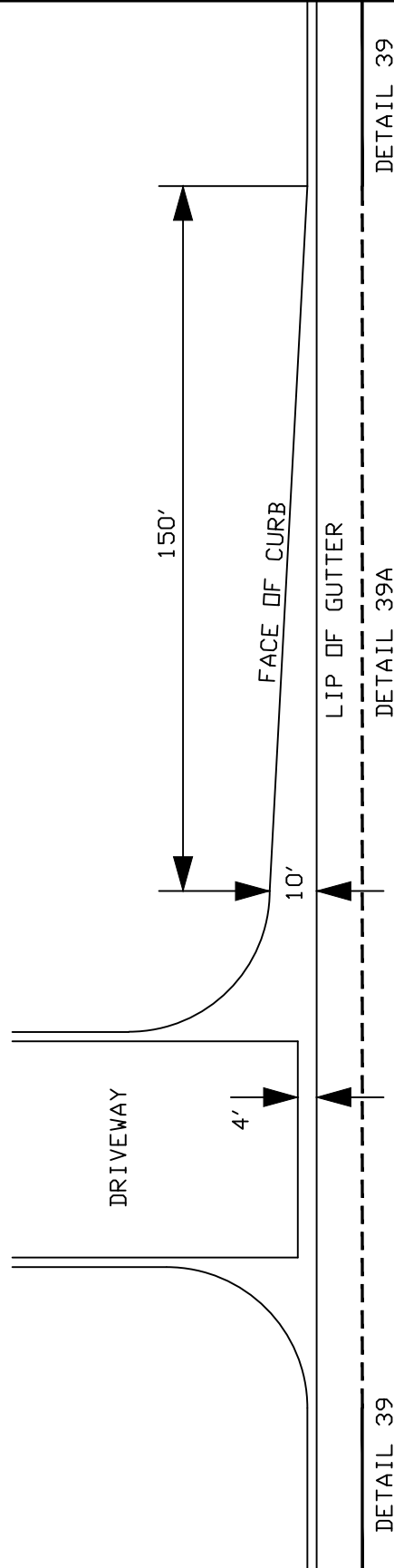

NOTES:

1. WHERE A CURB FLARE IS PROVIDED AT A DRIVEWAY, THE GUTTER FLOWLINE SHALL REMAIN PARALLEL WITH THE STREET CENTERLINE AND THE CURB FLARE TRANSITION SHALL BE CONSTRUCTED OF CONCRETE.
2. WHERE A CURB FLARE IS PROVIDED AT A STREET INTERSECTION, THE GUTTER FLOWLINE SHALL BE CONSTRUCTED PARALLEL TO THE CURB RETURN AND THE PAVEMENT SECTION WITHIN THE TRANSITION SHALL MATCH THE PAVEMENT SECTION OF THE MINOR STREET. NO CROSS GUTTERS SHALL BE ALLOWED.

FIG.
14-2

RIGHT-TURN
CURB FLARE



Approved: March 2022

CITY OF DIXON
ENGINEERING
DESIGN STANDARD



ENGINEERING DESIGN STANDARDS

SECTION 15 – TRANSPORTATION IMPACT ANALYSIS

DS-15-01. GENERAL: It is the policy of the City of Dixon that improvements be made to the City’s transportation network to provide adequate multimodal transportation facilities, as growth and development occur. To implement the policies of the Dixon General Plan and comply with the provisions of the California Environmental Quality Act (CEQA), the City of Dixon requires transportation impact analysis for significant development projects. The intent of this local transportation analysis is to determine a project’s traffic effects, to ascertain if the area transportation network is adequate to comply with the policies of the Dixon General Plan and to assist in the design and construction of sufficient infrastructure. In addition, all development projects must be analyzed for potential Vehicle Miles Traveled (VMT) impacts per the CEQA guidelines. The primary responsibility for assessing the transportation effects associated with a proposed development shall rest with the applicant, not the City. All local transportation and CEQA impact analyses shall be subject to review and approval by the City.

DS-15-02. DEFINITIONS:

1. “City Engineer” shall mean the City Engineer of the City of Dixon or his/ her appointed representative.
2. “Level of Service” (LOS) shall mean a scale which ranks intersection operations based on the amount of delay at an intersection. A complete description of the system is included in the Highway Capacity Manual published by the Transportation Research Board. Briefly the level of service ranking system is a scale with a range Level A (represents free-flow conditions) to Level F (represents severely congested or capacity conditions).
3. “A.M. Peak Hour” shall be the peak consecutive hour with the highest traffic volume during the 7–9 A.M. peak period.
4. “P.M. Peak Hour” shall be the peak consecutive hour with the highest traffic volume during the 4–6 P.M. peak period.
5. “Project” shall mean the entire plan as submitted for approval, including all phases within the plan boundaries and all proposed off-site improvements.
6. “Peak Hour” shall mean the greater of either the A.M. peak hour or the P.M. peak hour.
7. “Trip Generation Letter” shall mean a memorandum describing the trip generation characteristics of a project.
8. “Focused Local Transportation Analysis” shall mean a short report addressing project trip generation and selected local transportation topics.
9. “Full Local Transportation Analysis” shall mean a transportation report addressing trip generation, local transportation topics, and intersection capacity analysis.

DS-15-03. LOCAL TRANSPORTATION ANALYSIS (LTA) THRESHOLDS: A Trip Generation Letter, focused Local Transportation Analysis (LTA), or full LTA report may be required to determine the general adequacy of the area transportation network to accommodate a particular development project. Figure 15-1 and the following text describes the need for various analyses. Note that adjoining projects which are being processed concurrently by the same applicant that would cumulatively meet the criteria listed below, shall be considered as one project for the provisions of this policy.

TRIP GENERATION LETTER THRESHOLDS

At a minimum, all projects will require a trip generation letter stating the number of peak hour and daily trips expected to be generated. Projects expected to generate less than 50 peak hour trips will generally not require additional local transportation analysis. However, additional local transportation analysis may also be required if a project is expected to affect an intersection currently not meeting LOS standards, or if there is a specific site concern, as determined by the City Engineer. Table 15-1 lists some common land use quantities that would fall under the threshold at which a trip generation letter would generally suffice.

THRESHOLDS FOR FOCUSED LTA

Projects expected to generate at least 50 and less than 100 peak hour trips will generally require a trip generation letter that also addresses a subset of local transportation analysis topics (focused LTA). Additional local transportation analysis may also be required if a project is expected to affect an intersection currently not meeting LOS standards, or if there is a specific site concern, as determined by the City Engineer.

DS-15-04. TRIP GENERATION LETTER REQUIREMENTS: If the proposed project meets the above criteria for a trip generation letter, trip generation should be estimated for the proposed project using the latest version of the Institute of Transportation Engineers (ITE) Trip Generation Manual and/or trip generation surveys conducted at similar facilities¹. Trip generation calculations using the ITE Manual should apply either the average or fitted curve rate, as appropriate or directed by the City Engineer. If the estimated trip generation for the proposed project is fewer than 50 peak hour trips, a simple memorandum is necessary to document the weekday A.M. and P.M. peak hour and daily trip generation estimates and note the project does not trigger any additional LTA requirements.

**TABLE 15-1
COMMON DEVELOPMENT PROJECT TRIP GENERATION**

Land Use	ITE Land Use Code	Size Threshold	A.M. Peak Hour Trips	P.M. Peak Hour Trips
Single Family Residential	210	53 units	38	50
		106	74	100
Multifamily Residential - Low Rise	220	98 units	40	50
		196	78	100
General Office Building	712	23,300 sq. ft.	39	50
		46,500 sq. ft.	78	100
Hotel	310	85 rooms	39	50
		170 rooms	78	100
Sit-Down Restaurant	932	5,250 sq. ft.	50	48
		10,500 sq. ft.	100	95

Source: ITE Trip Generation 11th Edition (<https://itetripgen.org/>)

¹ Use of trip generation surveys collected independently from ITE should be verified with the City Engineer prior to use.

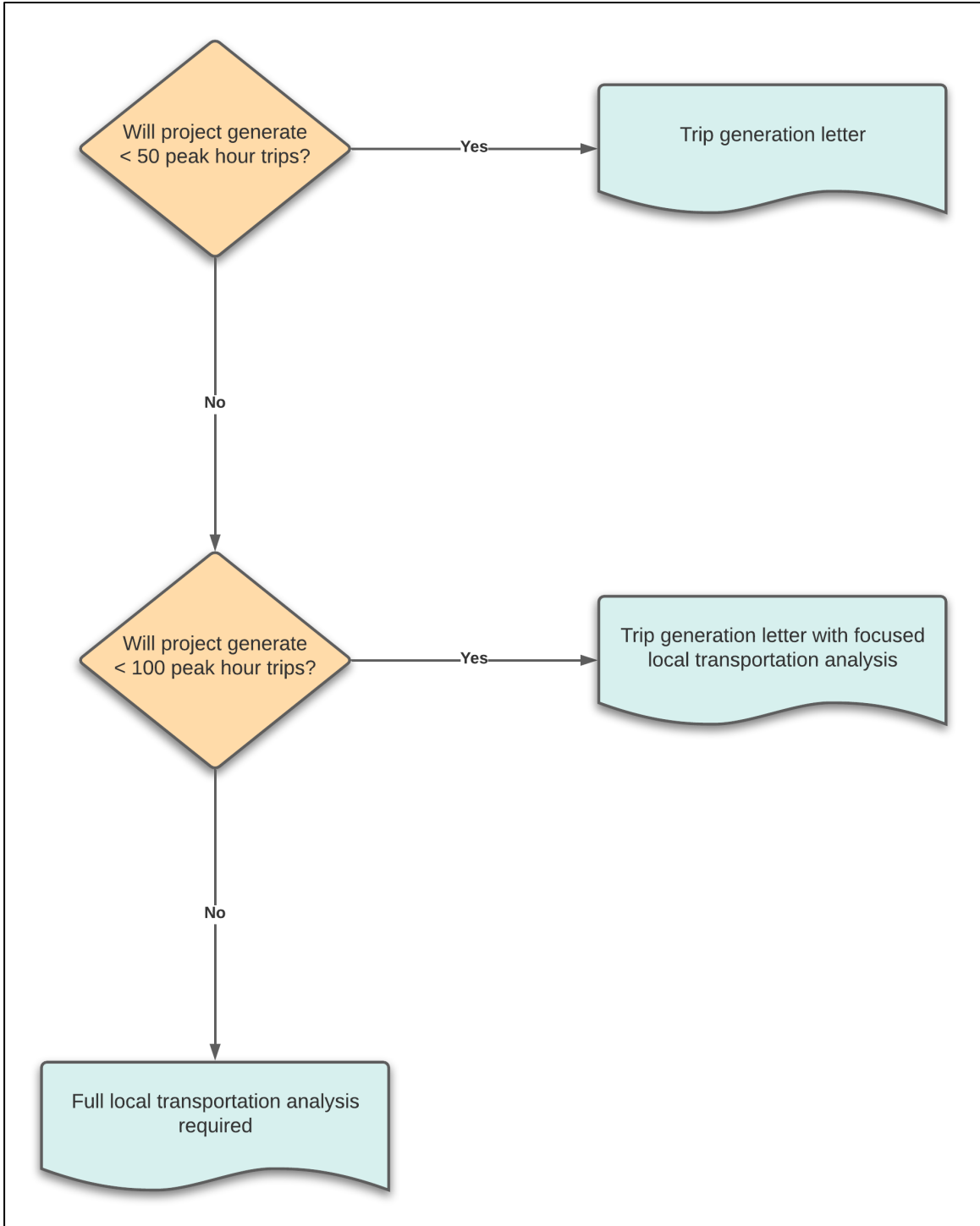

Figure 15-1 Local Transportation Analysis Requirements

DS-15-05. FOCUSED LOCAL TRANSPORTATION ANALYSIS

REQUIREMENTS: If the proposed project meets the above criteria for a focused LTA, trip generation should be estimated for the proposed project using the latest version of the Institute of Transportation Engineers (ITE) Trip Generation Manual and/or trip generation surveys conducted at similar facilities¹. Trip generation calculations using the ITE Manual should apply either the average or fitted curve rate, as appropriate or directed by the City Engineer. If the estimated peak hour trip generation for the proposed project at least 50 but fewer than 100 peak hour trips, a two-to three-page letter report would be required, including a discussion of the following items:

1. Weekday A.M. and P.M. peak hour and daily trip generation estimate for peak hour of adjacent street traffic.
2. Sight distance at project access point(s).
3. Safety evaluation within ¼ mile of project frontage (i.e., horizontal/vertical curves, sight distance, high collision locations, access spacing, street lighting/visibility, etc.).
4. Discussion/evaluation of onsite circulation and connectivity to adjacent parcels.
5. Bicycle and pedestrian issues shall be discussed, and planned facilities shall be compared with the City of Dixon General Plan to make sure any facilities proposed in the General Plan on the proposed project site are included as part of the proposed project. Potential path connections to adjacent parcels and streets shall be determined and discussed. For residential developments within ½ mile of a school, include a description of the walking route to school. Identify any unsafe walking conditions such as sidewalk gaps. A description of the nearest transit routes and stops should be included, if applicable.
6. Any additional topics as identified by the City Engineer.

At the City Engineer's discretion, additional analysis may be required once this initial information is collected. In general, addressing the items listed above would be sufficient.

DS-15-06. SCOPE FOR FULL LOCAL TRANSPORTATION ANALYSIS

REPORT: Local Transportation Analysis (LTA) reports shall be prepared by a qualified traffic engineer or transportation planner approved by the City Engineer. Prior to initiating an LTA, the City Engineer should be contacted to help establish the project study area, intersections for analysis, scenarios to be evaluated and any other pertinent information concerning the study. All LTA reports shall include the information described in the sections below.

EXECUTIVE SUMMARY AND INTRODUCTION

This section should include a brief description of the project and summary of project impacts. Any recommended improvements and/or operational issues shall be discussed.

EXISTING CONDITIONS

This section shall include the following elements:

1. Description of roadways in the study area, including roadway classification, number of lanes, average daily traffic volume, roadway width, presence or absence of sidewalks and/or bicycle facilities, nearest transit route, posted speed, presence or absence of on-street parking.
2. Existing intersection geometry, traffic control and geometric deficiencies at study intersections.

3. Existing turning movement counts at the study intersections measured within the previous 12 months. Weekday traffic counts should be conducted on Tuesdays, Wednesdays, or Thursdays (excluding weeks with a holiday). If possible, the counts should be conducted on days when schools are in session. Traffic counts should include motor vehicles, pedestrians, and bicyclists.
4. Crash data at study intersections and within the project vicinity for the most recent three-year period available.
5. Other pertinent features such as adjacent at grade railroad crossings.

Study area intersections shall be determined based on the following criteria (and subsequently verified by the City Engineer):

- All intersections of regional significance (arterials and collectors) where the traffic generated by the proposed project exceeds 10 percent of existing A.M. or P.M. peak hour total intersection traffic volumes within the City of Dixon city limits.
- All freeway ramps and sections that may be substantially affected by the project.
- All project access points onto the public roadway system.

The determination of study time periods should be made separately for each project based upon the peaking characteristics of the project traffic and surrounding street system. Office, industrial and residential projects should generally include weekday A.M. and P.M. peak hours. Retail projects may study only P.M. peak hour weekday time periods. Special circumstances may require mid-day or weekend analysis. Intersection operational analysis shall be conducted using the most recent version of the Highway Capacity Manual.

SITE CONDITIONS

The following conditions at and in the vicinity of the project site shall be discussed:

1. A brief description of the site plan, including a site plan layout shall be provided, including the number of driveways serving a parcel or site.
2. A review of the site conformance with the City's access standards Section 14, "Development Site Access," of these design standards. Each site access point shall be discussed separately. If the proposed site access does not meet City Standards, then the traffic study shall identify what modifications to the proposed site access would be necessary to meet City Standards and explain why these modifications are not proposed.
3. Sight distance at project access point(s) (verified by a registered engineer).
4. On site circulation, truck circulation, parking layout, and discussion/evaluation of connectivity to adjacent parcels.
5. Bicycle and pedestrian issues shall be discussed, and planned facilities shall be compared with the City of Dixon General Plan to make sure any facilities proposed in the General Plan on the proposed project site are included as part of the proposed project. Potential path connections to adjacent parcels and streets shall be determined and discussed. For residential developments within ½ mile of a school, include a description of the walking route to school. Identify any unsafe walking conditions such as sidewalk gaps. A description of the nearest transit routes and stops should be included, if applicable.

TRIP GENERATION AND DISTRIBUTION

A detailed description of the proposed project shall be provided including the intended land use and intensity of use. A summary table listing each specific use, the size involved, the trip generation rates used (total daily traffic and A.M./P.M. peak hours), and the resultant total trips generated shall be provided for the project site. The peak hours shall be that of the roadway network, not the proposed project. Trip generation shall be estimated using the most recent version of the ITE Trip Generation Manual or other sources previously agreed upon with the City Engineer. For industrial/surface mining projects, identify the number of truck trips that will be generated and design accommodations necessary to support these trucks.

Professional transportation sources are acceptable as sources for pass-by trip percentages. All pass-by trip percentages shall be verified by the City. Pass-by trips cannot be subtracted from driveways to the proposed project.

The assumed trip distribution and assignment shall represent the most logically traveled route for drivers accessing the proposed development. Trip distribution patterns for a project can use existing traffic counts, the City's travel demand model or a regional transportation model (project assignment only) or local knowledge. Trip distribution assumptions shall be reviewed by the City Engineer prior to their use.

The volume of site-generated traffic on the area's street system shall be shown on a map. The technical analysis steps, basic methods, and assumptions used in this work shall be clearly stated. These routes can be determined by observation of travel patterns to existing land uses in the study area.

INTERSECTION CAPACITY ANALYSIS

Intersection analysis (and freeway merge/diverge/weaving analysis, if needed) shall be conducted for the following scenarios:

1. Existing Conditions
2. Year of Opening Background Conditions (includes approved project trips)
3. Year of Opening Background Conditions plus Project Condition
4. Cumulative Year Conditions
5. Cumulative Year plus Project Conditions

*City Engineer may waive requirements for Cumulative Year scenarios if propose development generates equal to or fewer peak hour trips than are forecasted by the City's travel demand model.

The analysis shall include level of service, average delay and 95th percentile queuing. The intersection analysis for each scenario shall be summarized in a table with the calculation sheets provided in an appendix to the report.

The queuing analysis shall include consideration of the minimum required throat depth (MRTD) at the site public access points. The MRTD is to provide enough stacking distance for egressing vehicles, so the first drive aisle is not blocked and is measured from the back of the sidewalk to the edge of the first drive aisle. The MRTD shall be measured in car length increments of 25 feet and should be a minimum of 25 feet. The MRTD requirement does not apply to single family residential or duplex land uses. Listed in Table 15-2 are various types of "drive-thru" facilities and their respective storage

requirements. The distance is measured from the back of sidewalk at the street driveway to the service point. One space is equal to 25 feet. If the calculated MRTD is physically or unreasonable too long for the proposed development, then the study shall suggest ways to reduce the MRTD by either reducing the egressing demand volume, or by increasing the movement capacity.

**TABLE 15-2
VEHICLE STORAGE REQUIREMENTS**

TYPE OF FACILITY	VEHICLE STORAGE ¹
Drive-thru bank window	10 spaces
Drive-thru restaurant	10 spaces
Automatic car wash	10 spaces
Self-service car wash	3 spaces
Drive-in theater	15% of parking capacity
Hospital	1% of parking capacity
Service Station	4 spaces
Drive-thru dry cleaners	3 spaces
Self-storage mini warehouse	2 spaces

¹ The distance is measured from the back of sidewalk at the street driveway to the service point.

SIGNIFICANT TRANSPORTATION EFFECTS

The following thresholds should be used to determine if an effect is significant and requires improvements to address adverse effects.

Signalized Intersections: A project is considered to have a significant effect if it would:

- Result in a signalized intersection operating at an acceptable LOS (LOS D or better) to deteriorate to an unacceptable LOS; or
- Increase the average delay by more than 2 seconds at a signalized intersection that is operating at an unacceptable LOS without the project.

Unsignalized Intersections: A project is considered to have a significant effect if it would:

- Result in an unsignalized intersection movement/approach operating at an acceptable LOS to deteriorate to an unacceptable LOS, or
- Result in an increase in average delay of more than 2 seconds, at a movement/approach that is operating at an unacceptable LOS without the project, or
- Result in an unsignalized intersection meeting a traffic signal warrant.

Freeway Ramps: A project is considered to have a significant effect if it would:

- Result in or ramp queues exceeding storage capacity; or result in a decrease in safety.

Bicycle and Pedestrian Facilities: A project is considered to have a significant effect if it would:

- Eliminate or adversely affect an existing bikeway or pedestrian facility in a way that would discourage its use;
- Interfere with the implementation of a planned bikeway as shown in the General Plan or
- Fail to provide adequate access for bicyclists and pedestrians, resulting in unsafe conditions, including unsafe bicycle/pedestrian, bicycle/motor vehicle, or pedestrian/motor vehicle conflicts.

Safety: A project is considered to have a significant effect if it would:

- Substantially increase hazards due to a design feature (e.g., sharp curves or dangerous intersections) or incompatible uses

IMPROVEMENTS TO ADDRESS SIGNIFICANT ADVERSE EFFECTS

If a project is found to cause significant adverse transportation effects, a recommended improvement to address these should be identified. If a project causes a level of service deficiency, potential intersection improvements shall be proposed. At a minimum, the study shall consider improvements identified in the City of Dixon Capital Improvement Program (CIP). If an unsignalized study area intersection is proposed to be signalized, a signal warrant analysis based on the California Manual on Uniform Traffic Control Devices for Streets and Highways (MUTCD) shall be conducted.

If a project causes a LOS deficiency to a facility that is operating satisfactorily under the existing condition, the project is generally 100% responsible for implementing the improvement. If a project is found to cause a significant transportation effect at a facility that is already operating below the standard under existing conditions, a fair share project contribution should be calculated based on the project's share of traffic in excess of the acceptable standard. Similarly, project fair share contributions should be calculated for any improvements needed under background or cumulative conditions without the project.

If the local transportation analysis indicates the project will result in a level of service deficiency or other adverse transportation effects, the project shall be modified by the applicant to include the funding and construction of the recommended improvements to alleviate these effects, or be either:

1. Withdrawn by the applicant until improvements have been installed to improve the identified LOS deficiencies or adverse transportation effects, or
2. Denied by the City Council due to its negative impact on the transportation network.

As an alternative to the provisions above, the City Council may grant an exception to permit a project to cause or worsen a level of service in the peak hour for one or more intersections. The Planning Commission shall hold a public hearing to consider the requested exception and make a recommendation to the City Council related to the request. The City Council shall then hold a public hearing on the exception request and consider the recommendation of the Planning Commission prior to the approval of any such exception. An exception may be granted if the City Council makes one of the following alternative findings:

Finding 1

- a. That the affected transportation facilities in question are within an infill area where existing development limits the acquisition of right-of-way for mitigation or an isolated area where the subject facility serves a limited area as opposed to a large portion of the City, and
- b. There is no practical and feasible way to mitigate the adverse transportation effects, and
- c. The project resulting in the adverse transportation effects is of clear, overall public benefit.

Finding 2

- a. That a capital improvement project is reasonably scheduled to be completed within 3 years of the project which will improve the projected level of service to LOS "D" or better, and
- b. That the interim impact of the projected traffic congestion is offset by the public benefits of the project.

Finding 3

- a. The City has entered into a binding development agreement that commits the City to approve the proposed project or precludes the addition of improvement measures necessary to alleviate the adverse effects.

If improvements are funded and/or installed as part of the project to achieve level of service LOS “D” or better or otherwise address adverse transportation effects as specified above or, reimbursement may be provided through the following mechanisms as appropriate:

1. A benefit district established in accordance with the Municipal Code to collect revenues from other benefitting properties as they develop if the improvements are not specifically included in the Capital Improvement Program.
2. An assessment, community facilities district or other financing district established in accordance with State law.
3. A combination of the methods above as approved by the City Council.

APPENDIX

The following items shall be in the appendix, at a minimum:

- Existing traffic counts
- Level of service calculations
- Current site plan

DS-15-07. CEQA VMT ANALYSIS: Since July 2020, measures of automobile delay are no longer considered transportation impacts for the purposes of the California Environmental Quality Act (CEQA). In place of delay measures, Vehicle Miles Traveled (VMT) is now assessed as the primary measure of transportation impact under CEQA. Other potential CEQA impacts include conflicts with a plan or policy addressing the circulation system, creation of hazardous features, or inadequate emergency access (see the most current CEQA Guidelines for more information).

Measurement methodology, baseline VMT rates, thresholds of significance, screening criteria, and mitigation measures are presented in more detail in the *Dixon Senate Bill 743 Implementation Procedures Report*. The following sections summarize the screening criteria and VMT baselines as well as the required documentation.

VMT ANALYSIS THRESHOLDS

If a project meets any of the VMT screening criteria listed below (also summarized in Figure 15-2), the project can be assumed to have less than significant VMT impacts, no further VMT analysis is required, and the finding should be documented in a VMT screening letter. Projects not qualifying for any of the screening criteria will need to prepare a CEQA VMT impact analysis.

1. **Small Projects**- Projects generating fewer than 110 trips per day
2. **Affordable Housing**- Projects consisting of 100 percent affordable housing units
3. **Local Serving Retail** - generally less than 50,000 square feet per individual establishment

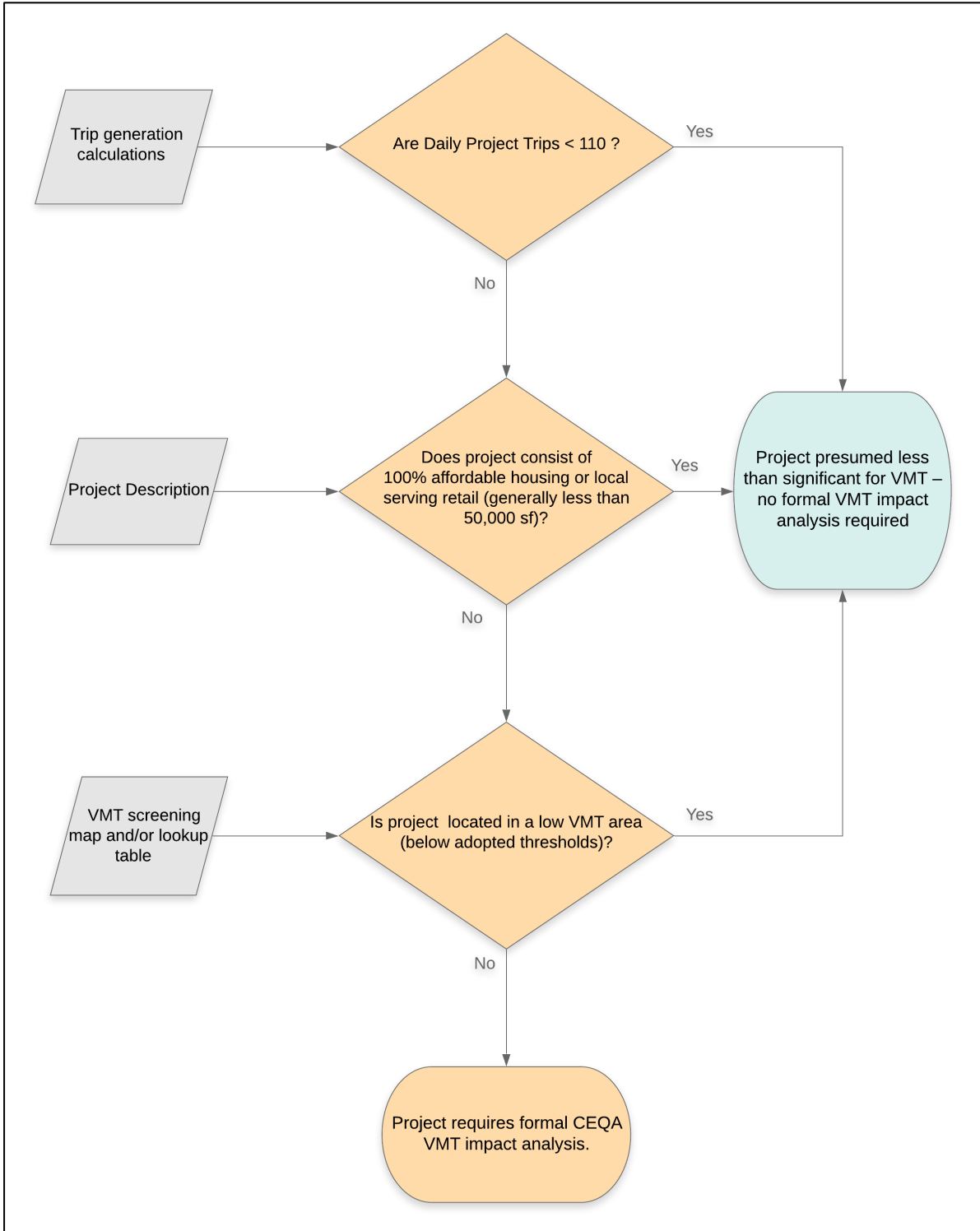

Figure 15-2 VMT Screening Process

4. **Transit Proximity** – Projects located within ½ mile of high-quality transit (as defined in Public Resources Code § 21064.3 – not currently applicable in Dixon)
5. **Project Location** – Projects located in a low VMT area as shown in Figures 15-3 and 15-4

For more information on the VMT screening criteria, please refer to the *Dixon Senate Bill 743 Implementation Procedures Report*.

VMT SCREENING LETTER

If a project qualifies for any of the VMT screening criteria listed above, the project can be assumed to have less than significant VMT impacts and no further VMT analysis is required. A brief memorandum documenting a statement regarding the presumption of less than significant VMT impacts should be submitted to the City Engineer for review.

CEQA VMT IMPACT ANALYSIS DOCUMENTATION

If a project does not qualify for VMT screening, a discussion of VMT impacts and mitigation should be documented in a formal CEQA analysis. Project associated VMT may be measured with the City of Dixon Travel Demand Model or alternative method to be approved by the City Engineer and should be compared to the thresholds of significance summarized below.

- *Residential projects* – should be compared to a threshold of significance of **18.5 VMT per capita**.
- *Employment projects* – should be compared to a threshold of significance of **14.1 VMT per employee**.
- *Retail or commercial projects* – any net increase in overall VMT would constitute an impact.
- *Medical uses* – may be analyzed using a similar approach to retail (net VMT impact). Medical facility employee VMT may also be considered for larger projects.
- *Industrial projects* – Determine whether there is significant light-duty vehicle VMT associated with the project, such as significant employee commute VMT. If so, compare the project VMT per employee to the appropriate threshold.
- *Mixed use projects* – Analyze each component land use separate or focus on predominant use (for example, analysis of a largely residential project with a small retail component could focus on the residential use).
- *Redevelopment projects* – consider the VMT of the previously existing use to account for the net impact.

For more details on analytical approaches and mitigation options, see the *Dixon Senate Bill 743 Implementation Procedures Report*. CEQA VMT reports should include the following sections:

- Project description to include quantities of each land use, assumed population for residential projects and employees.
- Description of analytical approach and resulting findings with respect to significant impacts and proposed mitigation.

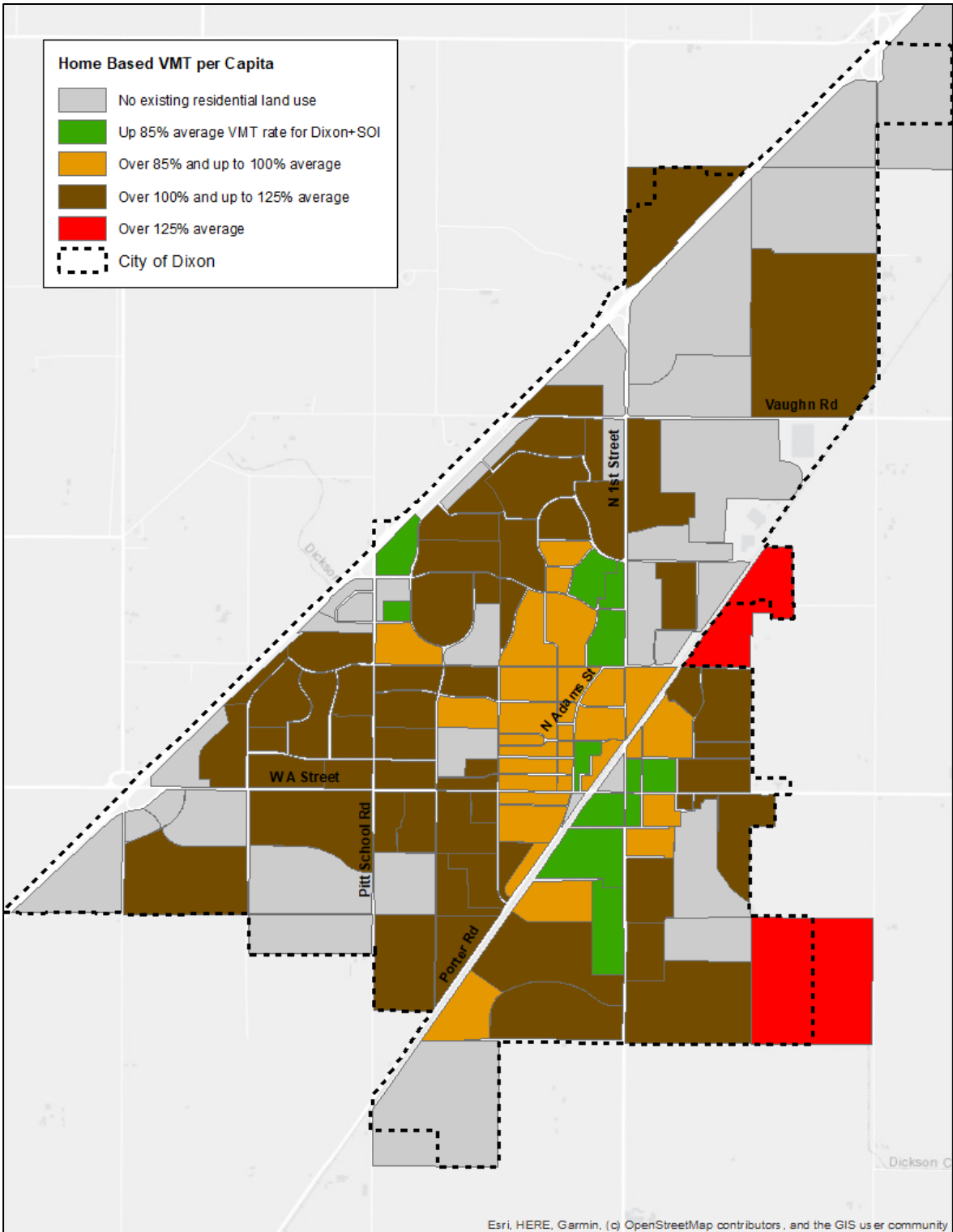

Figure 15-3 VMT Per Capita by TAZ

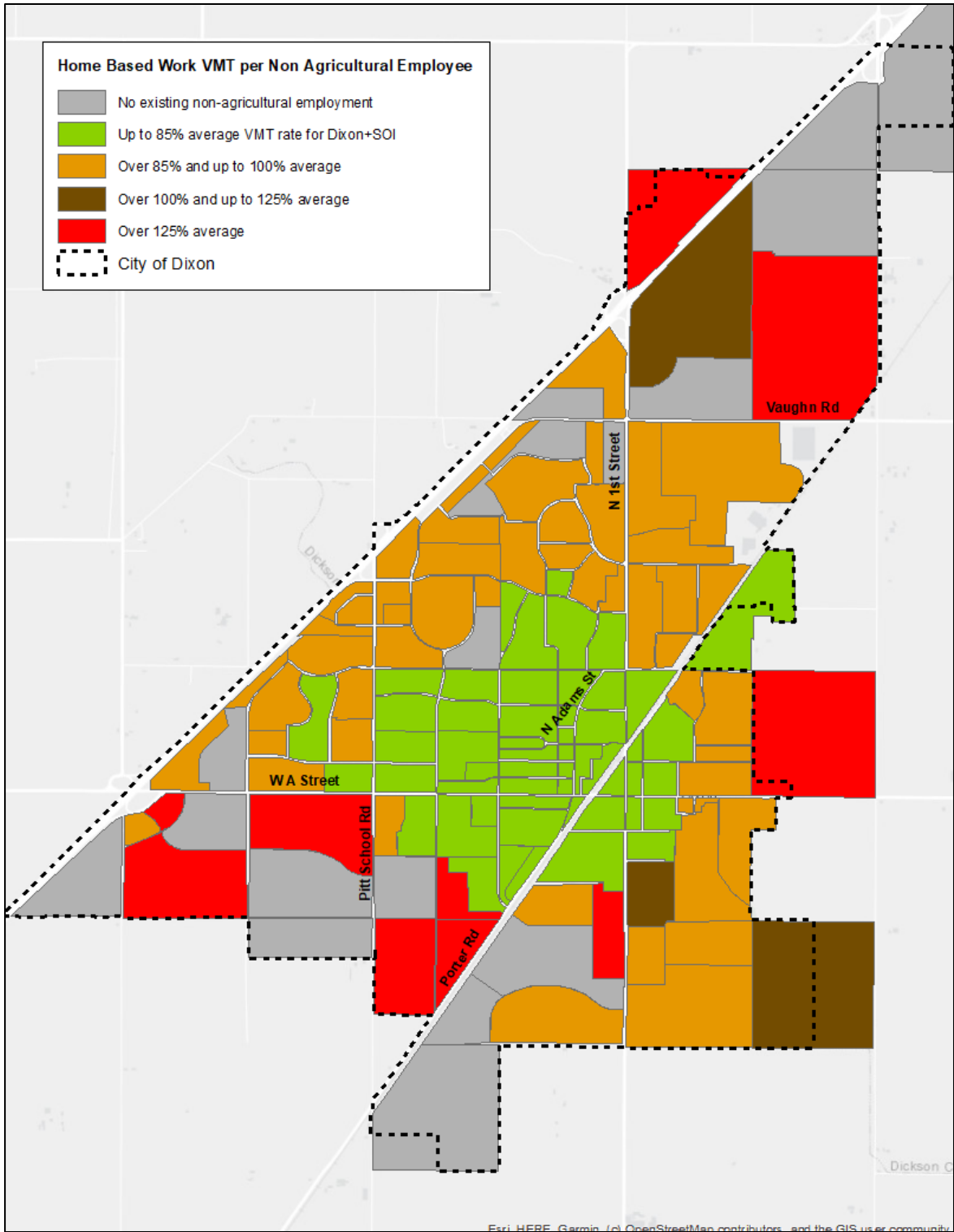

Figure 15-4 VMT per Employee by TAZ

DS-15-08.REPORT SUBMITTALS: The cover page of all Local Transportation Analysis reports shall be stamped and signed by a Transportation Professional. CEQA VMT screening letters and reports should be prepared by a qualified transportation planning professional. Transportation impact analysis should be performed as follows:

1. The analysis may be under contract to the City or the applicant if the analysis is not part of an environmental document. The analysis shall be under contract to the City or a City contractor if the analysis is part of an environmental document.
2. The analysis shall be prepared to the specification and scope of the City Engineer. If the analysis is part of an environmental document, the scope shall also be reviewed by the planner assigned as project manager for the environmental document.
3. The City reserves the right to require a peer review of analysis that is prepared under contract to the developer. Such peer review shall be prepared by or under contract to the City and funded by the applicant.
4. An electronic copy of the report shall be submitted to the Planning Department. Traffic studies that are not in compliance with the requirements set forth in these guidelines will be considered incomplete and may result in the application being deemed incomplete.
5. The Planning Department will forward one (1) copy of the report to the Department of Public Works. The Planning and Public Works Departments will then review the study data sources, methods and findings. Written comments from the Public Works Department will be provided to the Planning Department which will forward the comments to the applicant. The applicant and the transportation consultant will then have an opportunity to incorporate necessary revisions or responses as part of the final report.
6. Hard copies of the final report may be required for submittal to the Planning Department for Planning Commission Meetings or City Council Meetings. All copies of the study submitted shall become the property of the City.